



Decorative hardware / Engineering hardware / Door accessories hardware

JINCHENG HARDWARE INDUSTRY CO.,LTD

Add: No. 191, Wudong Industrial Zone,
Lile Town, Jianghai Dist, Jiangmen,
Guangdong, China 529060.

Tel: +86-750-3166208

Fax: +86-750-3166206

E-mail: sales@jincheng-hw.cc

http: //www.jincheng-hw.cc

ABOUT US

JinCheng Hardware Industry Co.,Ltd is a manufacturer and supplier of architectural hardware to the construction industry, is located at Jiangmen city, Guangdong province in China Near HK and Macao. JinCheng products are both durable and versatile.

The JinCheng quality range of Architectural Hardware includes door hinges, Door Lever handles, pull handles, door stoppers, series of door-used hardware and small size metal components, etc. We focus on customers service, high quality and competitive price, which leading our goods are popular in America, Canada, Europe, Southeast. Asia, Middle-East and other countries abroad.

JinCheng's extensive range of Architectural Hardware products offers a well-priced package of functionality and style. Please feel free to contact JinCheng if you have any special requirements or you would like one of our architectural consultants to call on you. We look forward to helping you and thank you for your interest and support.



JINCHENG HARDWARE
ELABORATE

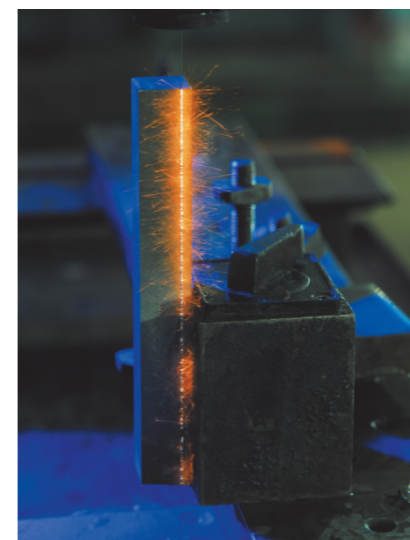

Zinc alloy product surface treatment sample



SC



SN



CP



BSN



SSS



PSS



AB



AC



AB



AC



YAB



SB



PVD gold



SRG



MB

Stainless steel surface treatment has:
SSS、PSS、AB、AC、PVD、RG、MB



BP



BSB



PC



NB

Zinc alloy surface treatment has :
SC、SN、CP、AB、AC、BP、BSN、
PC、PN、PVD、NB、YAB、MB



MB

Three-dimensional adjustable concealed hinge

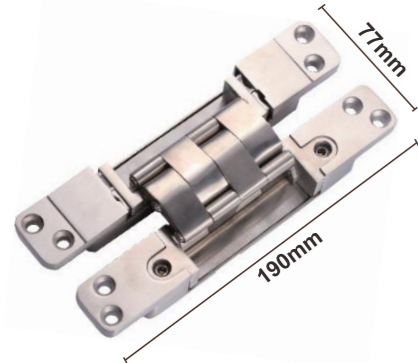

AG02 Three dimensional adjustable concealed hinge
SIZE:29×190mm



AG03 (Left open type)
AG04 (Right open type)
SIZE:30×110mm



AG05 (Left open type)
AG06 (Right open type)
SIZE:23×95mm

Hidden hinge for investment casting



BG01
SIZE:19×95mm



BG05
SIZE:28×118mm



BG02
SIZE:25×117mm



BG06
SIZE:13×60mm



BG03
SIZE:28×118mm



BG07
SIZE:16×70mm



BG04
SIZE:34×138mm

Zinc alloy concealed hinge



CG01
SIZE:12×60mm /
SIZE:13×60mm



CG02
SIZE:13×45mm



CG03
SIZE:16×70mm



CG04
SIZE:19×95mm



CG05
SIZE:25×117mm



CG06
SIZE:28×118mm



CG07
SIZE:34×138mm

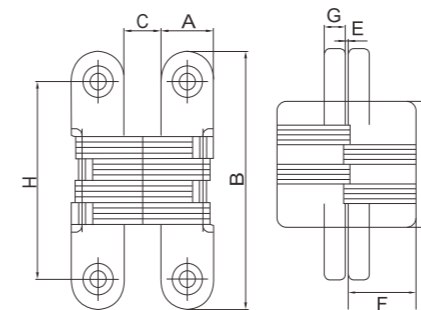

Outline dimensions of dark hinge

Zinc alloy dark hinge dimensions reference table

Dimension(mm)	A	B	C	D	E	F	G	H
34×138	34	27	138	74	2	59	11.5	outside : 114, inside : 104
28×118	28	22	118	61	2	41	9.5	outside : 95, inside : 88
25×117	25	18	117	63.5	1.5	37	11.5	92
19×95	19	13	95	50	1.5	27	9.5	74
16×70	16	11	70	34	1	23	7.5	52
12×60	12	8	60	29.8	1	27	5.9	42
13×45	13	8	45	19	1	18.2	5	32
28×117	27.7	23	117	64	3	41	12	89

Cast steel dark hinge dimensions reference table

Dimension(mm)	A	B	C	D	E	F	G	H
Three-dimensional hidden hinge	32	190	15	140	12	27	10	outside : 170, inside : 160
19×95	19	10.5	95	50	1.1	28	10.5	74
25×117	25	16	117	63	1	36.5	11.5	92
28×118	28	20.5	118	60	1.3	40.5	10.5	outside : 93, inside : 87.5
34×138	34	27	138	73	2.5	50	12.5	outside : 114, inside : 104



Door Stopper

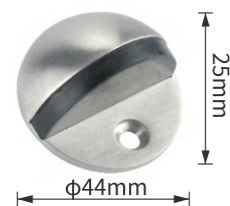

DH001
Stainless steel
Stamped hemispheres
SIZE: $\phi 44 \times 25$ mm

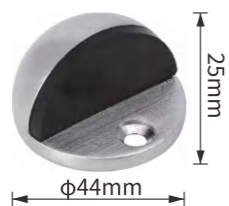

DH002
Stainless steel
Investment cast hemispheres
SIZE: $\phi 44 \times 25$ mm



DH003
Zinc alloy
Large hemisphere
SIZE: $\phi 46 \times 28$ mm

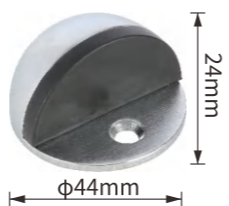

DH004 带
Zinc alloy
Studded hemisphere
SIZE: $\phi 44 \times 24$ mm

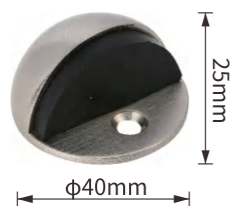

DH005
Stainless steel
investment casting
microhemisphere
SIZE: $\phi 40 \times 25$ mm

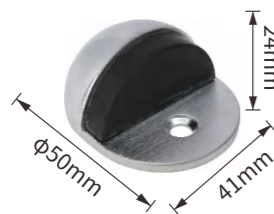

DH006 Zinc alloy
Stainless steel
investment casting
Elliptic hemisphere
SIZE: $\phi 42 \times 49$ mm



DH007
Stainless steel
investment casting
Foot hemisphere
SIZE: $\phi 46 \times 34$ mm



DH008
Zinc alloy
Foot hemisphere
SIZE: $\phi 46 \times 34$ mm



DH009
Zinc alloy
SIZE: $\phi 47 \times 27$ mm
(Optional stainless steel U-shaped plate for glass doors)



DH021
Zinc alloy
Hexagonal lighthouse
SIZE: $\phi 38 \times 75$ mm



DH022
Stainless steel
investment casting
Rounded lighthouse
SIZE: $\phi 38 \times 75$ mm



DH023
Zinc alloy
Rounded lighthouse
SIZE: $\phi 38 \times 75$ mm



DH024
Door top with hook
SIZE: $\phi 40 \times 88$ mm



DH025
No hook door top
SIZE: $\phi 46 \times 96$ mm



DH026
Hook top door
SIZE: $\phi 46 \times 96$ mm

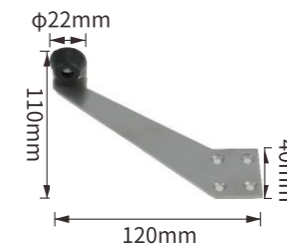

DH027
Stainless steel
Left coat hook
SIZE: 120×110 mm

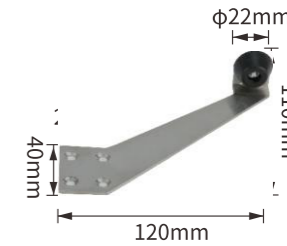

DH028
Stainless steel
Right coat hook
SIZE: 120×110 mm



DH029
Stainless steel
SIZE: $\phi 50 \times 80$ mm



DH030
Stainless steel
SIZE: $\phi 50 \times 88$ mm

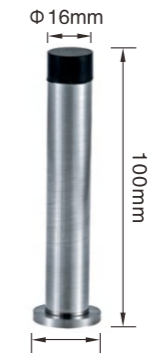

DH031
Stainless steel
SIZE: $\phi 25 \times 100$ mm

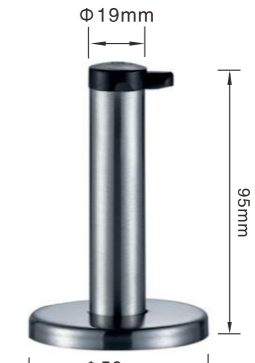

DH032
Stainless steel
SIZE: $\phi 50 \times 95$ mm



DH033
Aluminium alloy
SIZE: $\phi 25 \times 108$ mm



DH034
Stainless steel
SIZE: $\phi 30 \times 70$ mm



DH035
Stainless steel
SIZE: $\phi 30 \times 40$ mm



DH041
Copper door suction
SIZE: $\phi 43 \times 80$ mm



DH042
Stainless steel investment casting
SIZE: ϕ 45 \times 72mm



DH043
Zinc alloy
SIZE: ϕ 45 \times 72mm

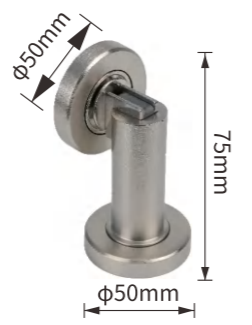

DH044
Zinc alloy
SIZE: ϕ 50 \times 75mm

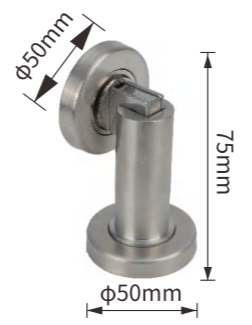

DH045
Stainless steel investment casting
SIZE: ϕ 50 \times 75mm

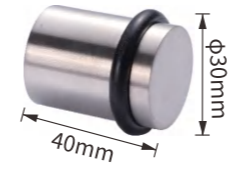

DH058
Stainless steel
SIZE: ϕ 30 \times 40mm



DH059
Aluminium alloy
SIZE: ϕ 35 \times 75mm



DH060
Stainless steel
SIZE: ϕ 40 \times 40mm

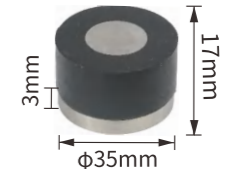

DH061
Stainless steel investment casting
SIZE: ϕ 35 \times 17mm



DH046
Door Stopper
SIZE: ϕ 50 \times 110mm



DH047
Range of regulation:
105-145mm
SIZE: ϕ 49 \times 92mm



DH048
Stainless steel investment casting
SIZE: ϕ 48 \times 75mm

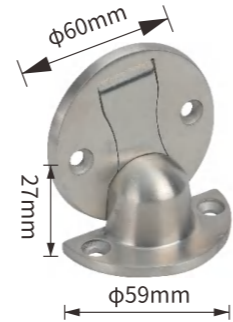

DH049
Stainless steel investment casting
SIZE: ϕ 60 \times 60 \times 27mm



DH062
Stainless steel investment casting
SIZE: ϕ 30 \times 45mm



DH063
Zinc alloy
SIZE: ϕ 30 \times 45mm



DH064
Stainless steel
SIZE: ϕ 30 \times 40mm

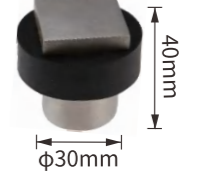

DH065
Stainless steel
SIZE: ϕ 30 \times 40mm

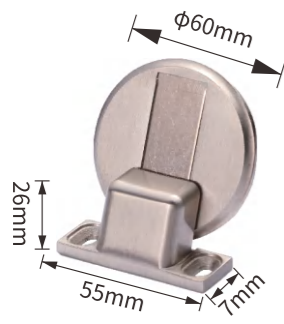

DH050
Stainless steel investment casting
SIZE: ϕ 60 \times 55 \times 7mm



DH051
Stainless steel investment casting
SIZE: ϕ 45 \times 31 \times 38mm



DH052
Zinc alloy
SIZE: 53 \times 30 \times 30mm



DH053
Stainless steel
SIZE: ϕ 30 \times 40mm



DH066

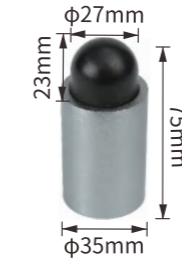

DH067
Aluminium alloy
SIZE: ϕ 35 \times 75mm

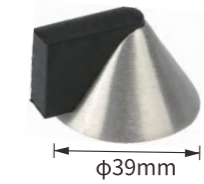

DH071
Zinc alloy
SIZE: ϕ 40 \times 23mm

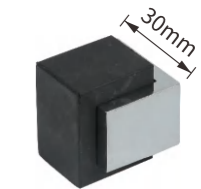

DH072
Stainless steel
SIZE: 30 \times 30 \times 30mm



DH054
Stainless steel
SIZE: ϕ 48 \times 82mm

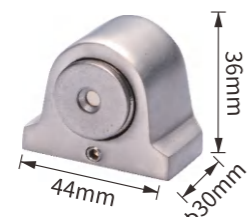

DH055
Stainless steel investment casting
SIZE: ϕ 44 \times 33 \times 36mm



DH056
Stainless steel investment casting
SIZE: ϕ 60 \times 60 \times 27mm

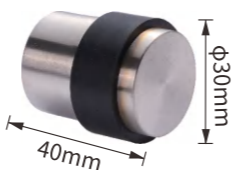

DH057
Stainless steel
SIZE: ϕ 30 \times 40mm



DH073
Stainless steel



DH074
Zinc alloy



DH075
Zinc alloy
SIZE: ϕ 45 \times 25mm



DH076
Stainless steel investment casting
SIZE: ϕ 45 \times 25mm

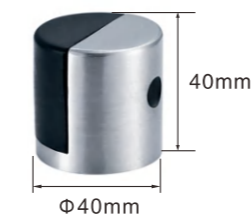

DH077
Stainless steel investment casting
SIZE: ϕ 40 \times 40mm

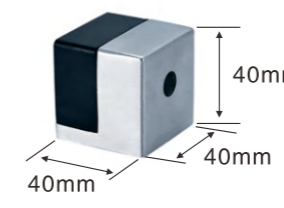

DH078
Stainless steel investment casting
SIZE: 40 \times 40 \times 40mm

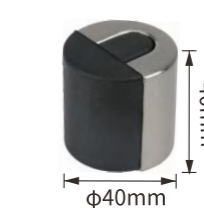

DH079
Stainless steel investment casting
SIZE: ϕ 40 \times 60mm



DH080
Aluminium
SIZE: ϕ 30 \times 40mm



* Part of the stainless steel door top height can be processed according to customer requirements.



Anti-theft buckle / Anti-theft chain

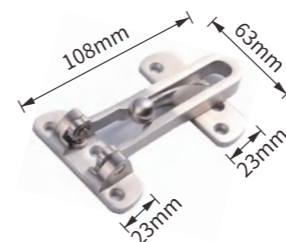

FM01
Stainless steel
investment casting
SIZE:108×63mm

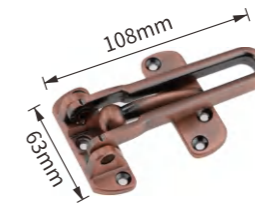

FM02
Zinc alloy
SIZE:108×63mm



FM03
Stainless steel
investment casting
SIZE:131×66mm

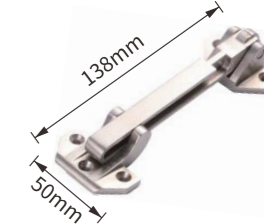

FM04
Zinc alloy
SIZE:138×50mm

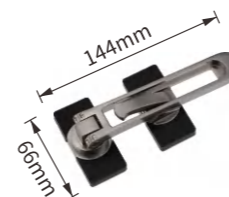

FM05
SIZE:144×66mm



FM06
Stainless steel
investment casting
SIZE:130×35mm
83×23mm

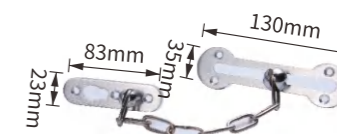

FM07
Zinc alloy
SIZE:130×35mm
83×23mm



FM08
SIZE:100×63×22mm

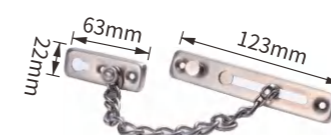

FM09
Stainless steel
SIZE:123×63×22mm



FM10

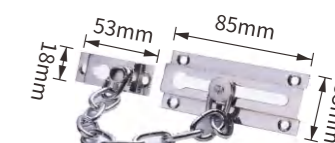

FM11
SIZE:85×53×18mm

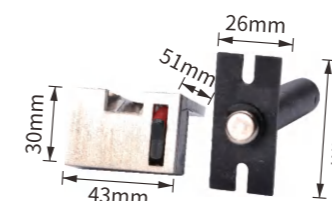

FM12
Stainless steel
investment casting
SIZE:51×43×30mm

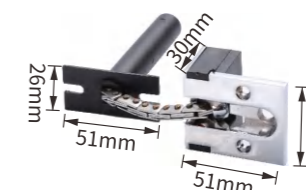

FM13
Zinc alloy
SIZE:51×43×30mm

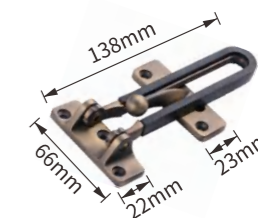

FM16
Zinc alloy
SIZE:133×66mm



FM17



FM18

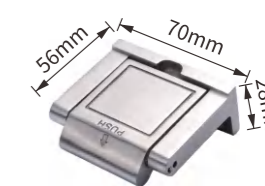

MX16
Stainless steel
investment casting
SIZE:70×56×28mm



Hidden bolt

A X (L Door latch)



Dimension(1)	150 × 25mm	200 × 25mm	250 × 25mm	300 × 25mm
Dimension(2)	150 × 22mm	200 × 22mm	250 × 22mm	300 × 22mm
Specification	6 inch	8 inch	10 inch	12 inch

B X (L Box insert)



Dimension	150 × 19mm	200 × 19mm	250 × 19mm	300 × 19mm
Specification	6 inch	8 inch	10 inch	12 inch
Dimension	450 × 19mm	600 × 19mm	1000 × 19mm	
Specification	18 inch	24 inch	40 inch	

C X (Tip plug) *The tip can be used for right Angle and rounded corner.



Dimension	160 × 17mm	200 × 17mm	255 × 17mm	300 × 17mm
Specification	6 inch	8 inch	10 inch	12 inch

D X (Barge bar joint) *Two optional, connecting rod length can be customized according to customer requirements.

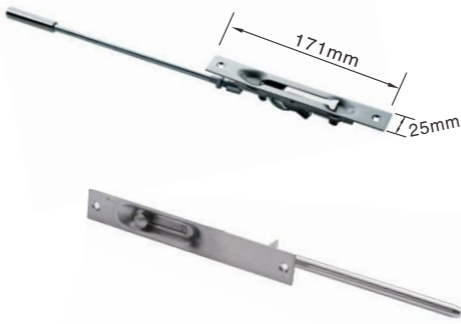

Connecting rod length (Plug included)	150mm	200mm	250mm	300mm
Specification	6 inch	8 inch	10 inch	12 inch

• Round rod barge rod insert

F X (Cast door insert) *Investment casting door insert is divided into: edge, edge, right Angle, rounded corner and other styles.



Dimension	150 × 19mm	200 × 19mm	250 × 19mm	300 × 19mm
Specification	6 inch	8 inch	10 inch	12 inch
Type	flanking			

F X (Zinc alloy door latch)



Dimension	150 × 19mm	200 × 19mm	250 × 19mm	300 × 19mm
Specification	6 inch	8 inch	10 inch	12 inch

Gate fixer



G01
Stainless steel stamping
SIZE:70×40mm
Rod length: 140mm/200mm/225mm

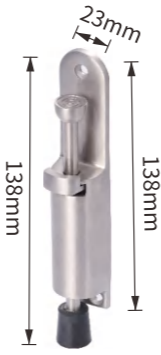

G03
Stainless steel investment casting
Zinc alloy
SIZE:153×30×140mm

Fire door touch bead



BC05
Stainless steel investment casting
SIZE: φ19 × 39mm



BC06



BC08
Stainless steel stamping
SIZE:89×20×20mm

H X (Nail door insert)



Dimension	150 × 20mm	200 × 20mm	250 × 20mm	300 × 20mm
Specification	6 inch	8 inch	10 inch	12 inch

I X (Automatic door plug)



I X

Intermediate wrench
SIZE:160×20mm



I X-L

Left wrench



I X-R

Right wrench

K X (Automatic door plug)
SIZE:147×20×55mm



J X (Center control door slot)
SIZE:285×22mm



L X, N X (Door plug)



L X



N X16



N X17



N X08



N X10



N X12

T X (Safety latch)



Dimension	150 × 22mm	200 × 22mm	250 × 22mm	300 × 22mm
Specification	6 inch	8 inch	10 inch	12 inch

P X (Brass door plug)



Dimension (optional)	98 × 25mm	118 × 25mm	138 × 25mm	158 × 25mm	188 × 25mm
----------------------	-----------	------------	------------	------------	------------

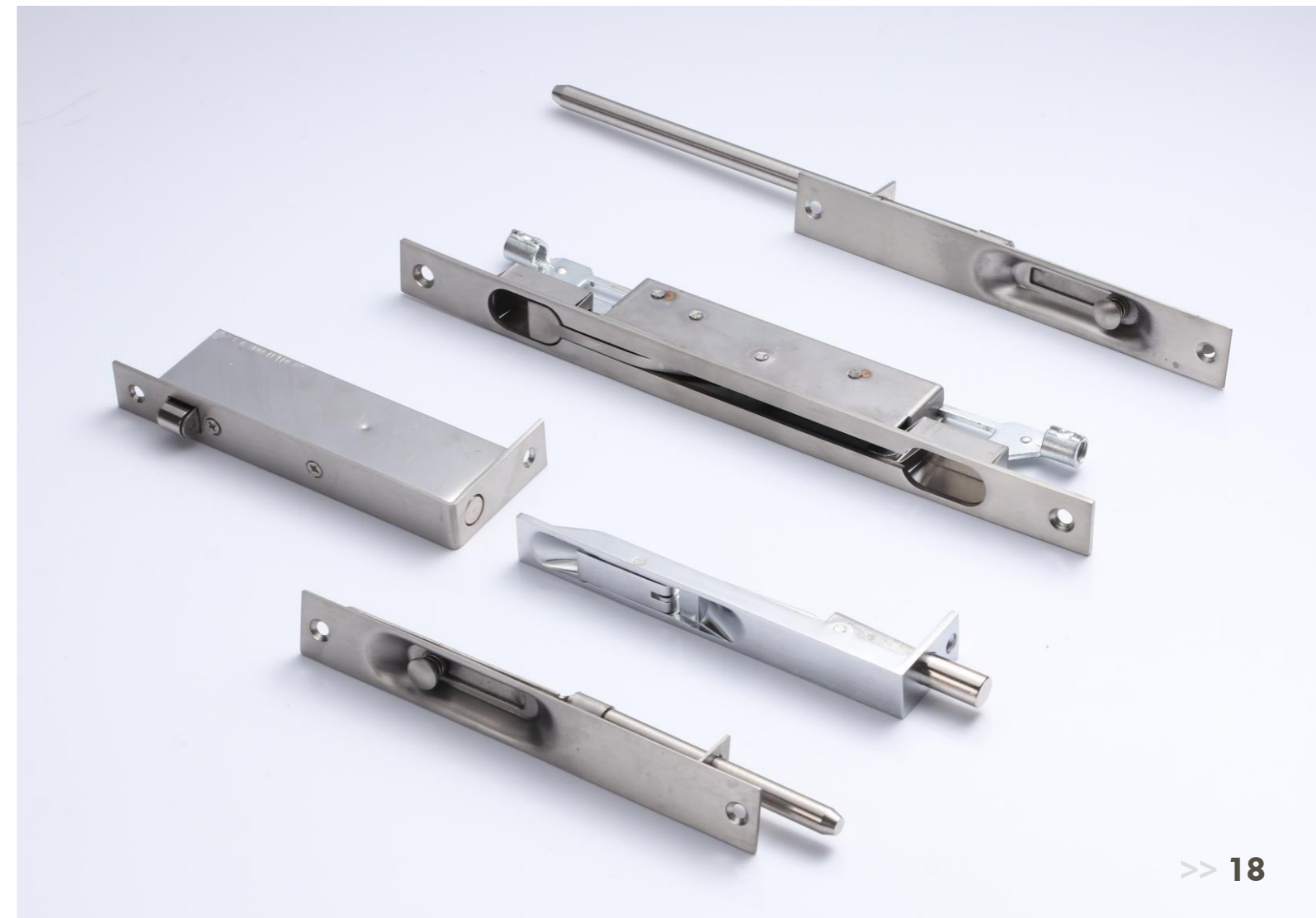

Bounce handle



MX15
Zinc alloy
SIZE: ϕ 34×34mm



MX17
SIZE: ϕ 75×13mm

Indicating wringer

One 8x8x60mm galvanized square stick per set of wringer (can be customized on request)

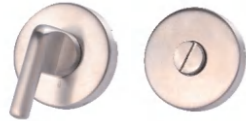

NX01



NX02



NX07



NX04



NX05



NX14



NX15

Mortise lock & Cylinder



BC01
SIZE: 77×77×23mm



BC02
Stainless steel
SIZE: 47×21×62mm

Sequencer



Large size sequencer
SIZE: 90×280mm



Small size sequencer
SIZE: 86×253mm



Stainless steel pull ring

X01-MX04: can be freely matched with the car side, round edge disc; The rings are available in diamond and column shapes, with center hole spacing of 45mm or 38mm.



MX01
SIZE: ϕ 75×13mm



MX02
SIZE: ϕ 75×13mm



MX03
SIZE: ϕ 75×13mm



MX04
SIZE: ϕ 75×13mm



MX09
SIZE: 180×62mm



MX11
SIZE: 180×62mm



MX12
SIZE: 100×20×23mm



MX14
SIZE: 70×24mm



MX05
SIZE: ϕ 75×12mm

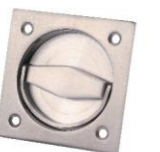

MX06
SIZE: 75×75×10mm



MX07
SIZE: 50×40mm



MX08
SIZE: 64×46mm



MX18
SIZE: 83×43mm



MX19
SIZE: 75×75×10mm



MX20
SIZE: 180×62mm



MX21
SIZE: ϕ 38×75mm

Furniture Conceal Handle



Furniture Conceal Handle has Separate face, dark hole two, special structure can be customized.

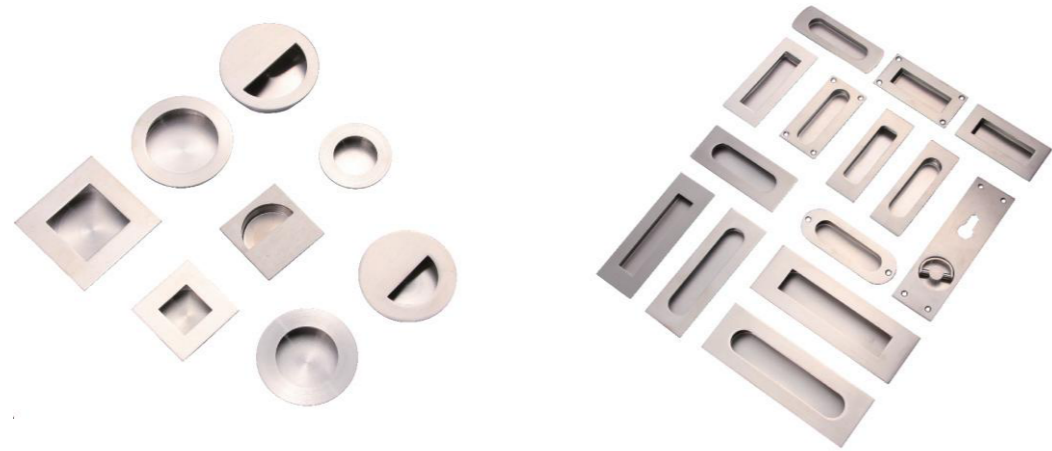

Dust Proof Strike

*Inner hole, height can be customized according to customer requirements.



FG01



FG02

Door Viewer



DV01



DV02



DV03



DV04



DV05

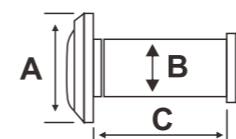

Door Viewer (door mirror) reference table					
Data unit (mm)	DV01	DV02	DV03	DV04	DV05
A	26	26	30	35	38
B	14	14	16	22	28
C	55	70	55	60	55

Number card

Digital brand style points: face, back welding nail, 3M paste three.
Size, font can be customized.



Sign Plate

Signs can be customized in any color or pattern, and there are two process options: etching and screen printing.

SP001

SIZE: 300×100×1.5mm
Handle size: ϕ 19×150mm



SP001

SIZE: ϕ 60×1.5mm
 ϕ 80×1.5mm
 ϕ 80×80×1.5mm

