

## Zinc Alloy Serial

**JINCHENG HARDWARE INDUSTRY CO.,LTD**

**Add:** No. 191, Wudong Industrial Zone, Lile Town,  
Jianghai Dist, Jiangmen, Guangdong, China 529060.

**Tel:** +86-750-3166208

**Fax:** +86-750-3166206

**E-mail:** sales@jincheng-hw.cc

**ZINC ALLOY SERIAL**  
www.jincheng-hw.com



**KA9-2006B CP/黑皮**

- ④ 表面处理: 亮铬/黑皮  
Finish: CP/黑皮
- ⑤ 材质: 锌合金  
Material: Zinc Alloy
- ⑥ 适用门厚: 38-50mm  
Door Thickness: 38-50mm
- ⑦ 适配锁体: 8550/7255  
Lock body: 8550/7255
- ⑧ 适用范围: 户外门、大门、别墅门、房门  
Available For: Doors Inside And Outside The House And Gate
- ⑨ 适用标准: QB/T2474-2000 GB21556-2008  
Applicable Standards: QB/T2474-2000 GB21556-2008

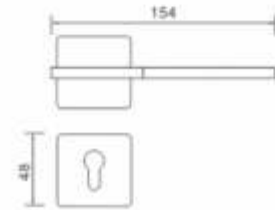

**KA9-2006B BL/黑皮**



**KA9-2006B RGS/棕皮**



**KA82-9902 DBN/棕皮**

- ④ 表面处理: 黑铬/棕皮  
Finish: DBN/棕皮
- ⑤ 材质: 锌合金  
Material: Zinc Alloy
- ⑥ 适用门厚: 38-50mm  
Door Thickness: 38-50mm
- ⑦ 适配锁体: 8550/7255  
Lock body: 8550/7255
- ⑧ 适用范围: 户外门、大门、别墅门、房门  
Available For: Doors Inside And Outside The House And Gate
- ⑨ 适用标准: QB/T2474-2000 GB21556-2008  
Applicable Standards: QB/T2474-2000 GB21556-2008

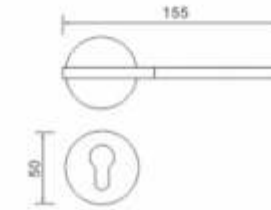

**KA82-9902 BL/黑皮**



**KA82-9902 CP/黑皮**



**KA9-2006 BL**

- ④ 表面处理: 亮铬  
Finish: BL
- ⑤ 材质: 锌合金  
Material: Zinc Alloy
- ⑥ 适用门厚: 38-50mm  
Door Thickness: 38-50mm
- ⑦ 适配锁体: 8550/7255  
Lock body: 8550/7255
- ⑧ 适用范围: 户外门、大门、别墅门、房门  
Available For: Doors Inside And Outside The House And Gate
- ⑨ 适用标准: QB/T2474-2000 GB21556-2008  
Applicable Standards: QB/T2474-2000 GB21556-2008

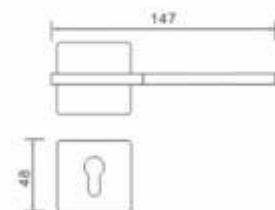

**KA9-2006 COF**



**KA9-2006 BS**



**KA82-9903 DBN**

- ④ 表面处理: 亮铬  
Finish: DBN
- ⑤ 材质: 锌合金  
Material: Zinc Alloy
- ⑥ 适用门厚: 38-50mm  
Door Thickness: 38-50mm
- ⑦ 适配锁体: 8550/7255  
Lock body: 8550/7255
- ⑧ 适用范围: 户外门、大门、别墅门、房门  
Available For: Doors Inside And Outside The House And Gate
- ⑨ 适用标准: QB/T2474-2000 GB21556-2008  
Applicable Standards: QB/T2474-2000 GB21556-2008

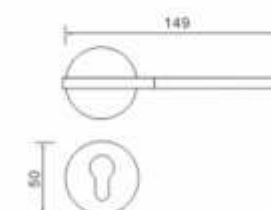

**KA82-9903 BL**



**KA82-9903 CP**



### KA9-2005 BL •

- ④ 表面处理: 镀黑  
Finish: BL
- ① 材质: 锌合金  
Material: Zinc Alloy
- ④ 适用门厚: 38-50mm  
Door Thickness: 38-50mm
- ① 适配锁体: 8550/7255  
Lock body: 8550/7255
- ⑧ 适用范围: 户外门、大门、别墅门、房门  
Available For: Doors Inside And Outside The House And Gate
- ④ 适用标准: QB/T2474-2000 GB21556-2008  
Applicable Standard: QB/T2474-2000 GB21556-2008

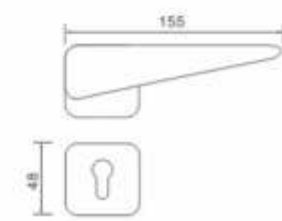

### KA9-2005 DSN •

### KA9-2005 DBN •

- ④ 表面处理: 黑镍  
Finish: DBN
- ① 材质: 锌合金  
Material: Zinc Alloy
- ④ 适用门厚: 38-50mm  
Door Thickness: 38-50mm
- ① 适配锁体: 8550/7255  
Lock body: 8550/7255
- ⑧ 适用范围: 户外门、大门、别墅门、房门  
Available For: Doors Inside And Outside The House And Gate
- ④ 适用标准: QB/T2474-2000 GB21556-2008  
Applicable Standard: QB/T2474-2000 GB21556-2008

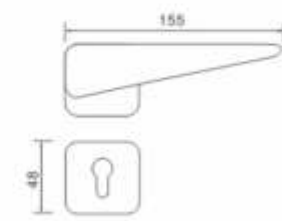

### KA9-2005 COF •



**KA5-2007 BL •**

- ⑤ 表面处理: 哑黑  
Finish: BL
- ⑥ 材质: 锌合金  
Material: Zinc Alloy
- ④ 适用门厚: 38-50mm  
Door Thickness: 38-50mm
- ① 适配锁体: 8550/7255  
Lock body: 8550/7255
- ⑧ 适用范围: 户外门、大门、别墅门、房门  
Available For: Doors Inside And Outside The House And Gate
- ⑨ 适用标准: GB/T2474-2000 GB21556-2008  
Applicable Standard: GB/T2474-2000 GB21556-2008

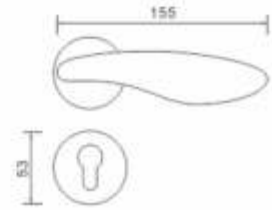

**KA5-2007 PVD •**



**KA5-2007 BS •**

- ⑤ 表面处理: 黑镍拉丝  
Finish: BS
- ⑥ 材质: 锌合金  
Material: Zinc Alloy
- ④ 适用门厚: 38-50mm  
Door Thickness: 38-50mm
- ① 适配锁体: 8550/7255  
Lock body: 8550/7255
- ⑧ 适用范围: 户外门、大门、别墅门、房门  
Available For: Doors Inside And Outside The House And Gate
- ⑨ 适用标准: GB/T2474-2000 GB21556-2008  
Applicable Standard: GB/T2474-2000 GB21556-2008

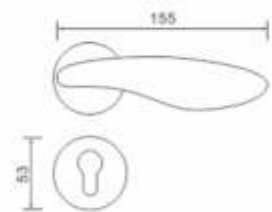

**KA5-2007 COF •**



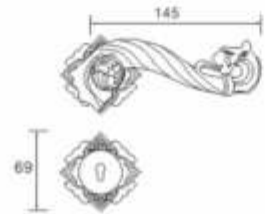

### KA29-9769 PVD

- ⑤ 表面处理: 镀金  
Finish: PVD
- ④ 材质: 锌合金  
Material: Zinc Alloy
- ④ 适用门厚: 38-50mm  
Door Thickness: 38-50mm
- ④ 适配锁体: 8550/7255  
Lock body: 8550/7255
- ⑧ 适用范围: 户外门、大门、别墅门、房门  
Available For: Doors Inside And Outside The House And Gate
- ⑧ 适用标准: QB/T2474-2000 GB21556-2008  
Applicable Standard: QB/T2474-2000 GB21556-2008



### KA29-9769 COF

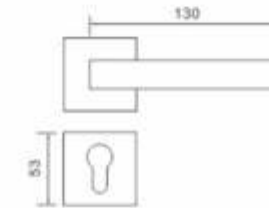

### KA9-2004 BS

- ⑤ 表面处理: 黑镍拉丝  
Finish: BS
- ④ 材质: 锌合金  
Material: Zinc Alloy
- ④ 适用门厚: 38-50mm  
Door Thickness: 38-50mm
- ④ 适配锁体: 8550/7255  
Lock body: 8550/7255
- ⑧ 适用范围: 户外门、大门、别墅门、房门  
Available For: Doors Inside And Outside The House And Gate
- ⑧ 适用标准: QB/T2474-2000 GB21556-2008  
Applicable Standard: QB/T2474-2000 GB21556-2008



### KA9-2004 COF



### KA9-2004 DSN

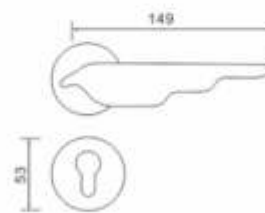

### KA5-2003 DSN

- ⑤ 表面处理: 哑光镍拉丝  
Finish: DSN
- ④ 材质: 锌合金  
Material: Zinc Alloy
- ④ 适用门厚: 38-50mm  
Door Thickness: 38-50mm
- ④ 适配锁体: 8550/7255  
Lock body: 8550/7255
- ⑧ 适用范围: 户外门、大门、别墅门、房门  
Available For: Doors Inside And Outside The House And Gate
- ⑧ 适用标准: QB/T2474-2000 GB21556-2008  
Applicable Standard: QB/T2474-2000 GB21556-2008



### KA5-2003 BS

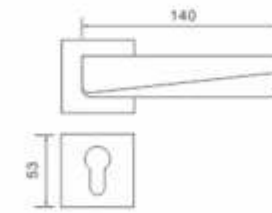

### KA9-2002 BL

- ⑤ 表面处理: 电镀  
Finish: BL
- ④ 材质: 锌合金  
Material: Zinc Alloy
- ④ 适用门厚: 38-50mm  
Door Thickness: 38-50mm
- ④ 适配锁体: 8550/7255  
Lock body: 8550/7255
- ⑧ 适用范围: 户外门、大门、别墅门、房门  
Available For: Doors Inside And Outside The House And Gate
- ⑧ 适用标准: QB/T2474-2000 GB21556-2008  
Applicable Standard: QB/T2474-2000 GB21556-2008



### KA9-2002 DSN



### KA9-2002 BS



**KA5-916 BS •**

- ④ 表面处理: 黑镍拉丝  
Finish: BS
- ④ 材质: 锌合金  
Material: Zinc Alloy
- ④ 适用门厚: 38-50mm  
Door Thickness: 38-50mm
- ④ 适配锁体: 8550/7255  
Lock body: 8550/7255
- ⑧ 适用范围: 户外门、大门、别墅门、房门  
Available For: Doors Inside And Outside The House And Gate
- ⑧ 适用标准: QB/T2474-2000 GB21556-2008  
Applicable Standards: QB/T2474-2000 GB21556-2008

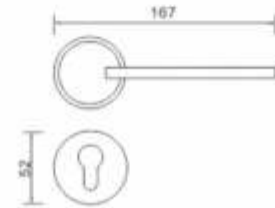

**KA5-916 COF •**



**KA5-916 DSN •**



**KA9-9920 BL •**

- ④ 表面处理: 拉丝  
Finish: BL
- ④ 材质: 锌合金  
Material: Zinc Alloy
- ④ 适用门厚: 38-50mm  
Door Thickness: 38-50mm
- ④ 适配锁体: 8550/7255  
Lock body: 8550/7255
- ⑧ 适用范围: 户外门、大门、别墅门、房门  
Available For: Doors Inside And Outside The House And Gate
- ⑧ 适用标准: QB/T2474-2000 GB21556-2008  
Applicable Standards: QB/T2474-2000 GB21556-2008

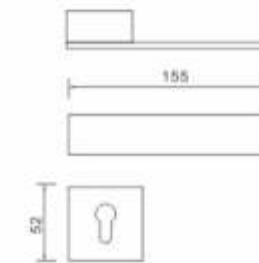

**KA9-9920 DSN •**



**KA9-9920 BS •**



**KA82-9910 DBN •**

- ④ 表面处理: 黑镍  
Finish: DBN
- ④ 材质: 锌合金  
Material: Zinc Alloy
- ④ 适用门厚: 38-50mm  
Door Thickness: 38-50mm
- ④ 适配锁体: 8550/7255  
Lock body: 8550/7255
- ⑧ 适用范围: 户外门、大门、别墅门、房门  
Available For: Doors Inside And Outside The House And Gate
- ⑧ 适用标准: QB/T2474-2000 GB21556-2008  
Applicable Standards: QB/T2474-2000 GB21556-2008

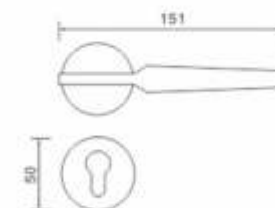

**KA82-9910 CP •**



**KA5-9919 BL •**

- ④ 表面处理: 拉丝  
Finish: BL
- ④ 材质: 锌合金  
Material: Zinc Alloy
- ④ 适用门厚: 38-50mm  
Door Thickness: 38-50mm
- ④ 适配锁体: 8550/7255  
Lock body: 8550/7255
- ⑧ 适用范围: 户外门、大门、别墅门、房门  
Available For: Doors Inside And Outside The House And Gate
- ⑧ 适用标准: QB/T2474-2000 GB21556-2008  
Applicable Standards: QB/T2474-2000 GB21556-2008

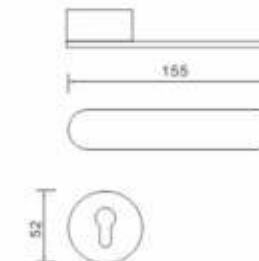

**KA5-9919 BS •**



**KA5-9919 CP •**



**KA9-9905 DBN •**

- ④ 表面处理: 亚摩  
Finish: DBN
- ⑤ 材质: 锌合金  
Material: Zinc Alloy
- ⑥ 适用门厚: 38-50mm  
Door Thickness: 38-50mm
- ⑦ 适配锁体: 8550/7255  
Lock body: 8550/7255
- ⑧ 适用范围: 户内门、大门、别墅门、房门  
Available For: Doors Inside And Outside The House And Gate
- ⑨ 适用标准: QB/T2474-2000 GB21556-2008  
Applicable Standard: QB/T2474-2000 GB21556-2008

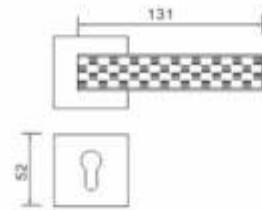

**KA9-9905 CP •**



**KA9-9905 PVD •**



**KA9-9906 BS/BL •**

- ④ 表面处理: 亚摩拉丝/亚摩  
Finish: BS/BL
- ⑤ 材质: 锌合金  
Material: Zinc Alloy
- ⑥ 适用门厚: 38-50mm  
Door Thickness: 38-50mm
- ⑦ 适配锁体: 8550/7255  
Lock body: 8550/7255
- ⑧ 适用范围: 户内门、大门、别墅门、房门  
Available For: Doors Inside And Outside The House And Gate
- ⑨ 适用标准: QB/T2474-2000 GB21556-2008  
Applicable Standard: QB/T2474-2000 GB21556-2008

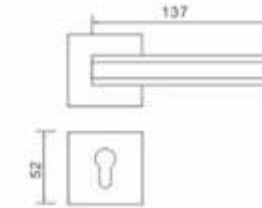

**KA9-9906 BL/CP •**



**KA9-9906 BL/PVD •**



**KA9-9924 BL •**

- ④ 表面处理: 亚摩  
Finish: BL
- ⑤ 材质: 锌合金  
Material: Zinc Alloy
- ⑥ 适用门厚: 38-50mm  
Door Thickness: 38-50mm
- ⑦ 适配锁体: 8550/7255  
Lock body: 8550/7255
- ⑧ 适用范围: 户内门、大门、别墅门、房门  
Available For: Doors Inside And Outside The House And Gate
- ⑨ 适用标准: QB/T2474-2000 GB21556-2008  
Applicable Standard: QB/T2474-2000 GB21556-2008

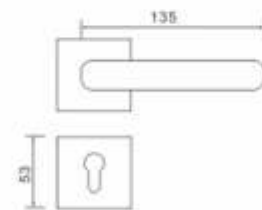

**KA9-9924 COF •**



**KA9-9924 DSN •**



**KA9-9918 BS •**

- ④ 表面处理: 亚摩拉丝  
Finish: BS
- ⑤ 材质: 锌合金  
Material: Zinc Alloy
- ⑥ 适用门厚: 38-50mm  
Door Thickness: 38-50mm
- ⑦ 适配锁体: 8550/7255  
Lock body: 8550/7255
- ⑧ 适用范围: 户内门、大门、别墅门、房门  
Available For: Doors Inside And Outside The House And Gate
- ⑨ 适用标准: QB/T2474-2000 GB21556-2008  
Applicable Standard: QB/T2474-2000 GB21556-2008

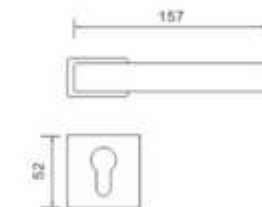

**KA9-9918 DAB •**



**KA9-9918 DSN •**

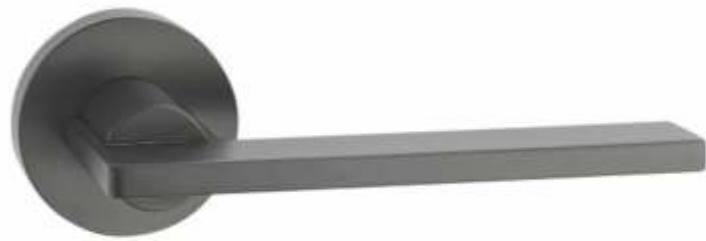

**KA5-9911 BS •**

- ④ 表面处理: 黑镍拉丝  
Finish: BS
- ⑤ 材质: 锌合金  
Material: Zinc Alloy
- ⑥ 适用门厚: 38-50mm  
Door Thickness: 38-50mm
- ⑦ 适配锁体: 8550/7255  
Lock body: 8550/7255
- ⑧ 适用范围: 户外门, 大门, 别墅门, 房门  
Available For: Doors Inside And Outside The House And Gate
- ⑨ 适用标准: QB/T2474-2000 GB21556-2008  
Applicable Standard: QB/T2474-2000 GB21556-2008

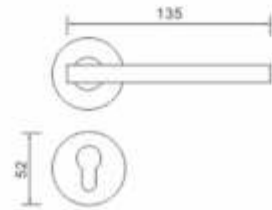

**KA5-9911 DSN/BL •**



**KA5-9915 DBN/棕皮 •**

- ④ 表面处理: 黑镍/棕皮  
Finish: DBN/棕皮
- ⑤ 材质: 锌合金  
Material: Zinc Alloy
- ⑥ 适用门厚: 38-50mm  
Door Thickness: 38-50mm
- ⑦ 适配锁体: 8550/7255  
Lock body: 8550/7255
- ⑧ 适用范围: 户外门, 大门, 别墅门, 房门  
Available For: Doors Inside And Outside The House And Gate
- ⑨ 适用标准: QB/T2474-2000 GB21556-2008  
Applicable Standard: QB/T2474-2000 GB21556-2008

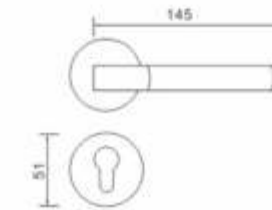

**KA5-9915 CP/黑皮 •**



**KA5-9915 PVD/驼皮 •**



**KA5-9908 BL/CP •**

- ④ 表面处理: 亮黑/镀铬  
Finish: BL/CP
- ⑤ 材质: 锌合金  
Material: Zinc Alloy
- ⑥ 适用门厚: 38-50mm  
Door Thickness: 38-50mm
- ⑦ 适配锁体: 8550/7255  
Lock body: 8550/7255
- ⑧ 适用范围: 户外门, 大门, 别墅门, 房门  
Available For: Doors Inside And Outside The House And Gate
- ⑨ 适用标准: QB/T2474-2000 GB21556-2008  
Applicable Standard: QB/T2474-2000 GB21556-2008

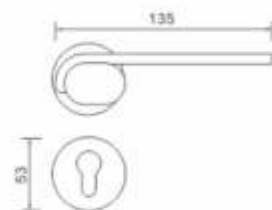

**KA5-9908 BS/DSN •**



**KA5-9908 BL/PVD •**



**KA5-9922 RGS/橙皮 •**

- ④ 表面处理: 金拉丝/橙皮  
Finish: RGS/橙皮
- ⑤ 材质: 锌合金  
Material: Zinc Alloy
- ⑥ 适用门厚: 38-50mm  
Door Thickness: 38-50mm
- ⑦ 适配锁体: 8550/7255  
Lock body: 8550/7255
- ⑧ 适用范围: 户外门, 大门, 别墅门, 房门  
Available For: Doors Inside And Outside The House And Gate
- ⑨ 适用标准: QB/T2474-2000 GB21556-2008  
Applicable Standard: QB/T2474-2000 GB21556-2008

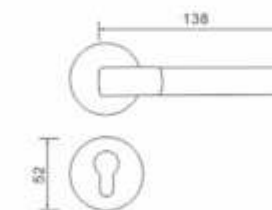

**KA5-9922 DBN/棕皮 •**



**KA5-9922 CP/黑皮 •**





**A5-988 BL •**

- ④ 表面处理: 哑黑  
Finish: BL
- ⑤ 材质: 锌合金  
Material: Zinc Alloy
- ⑥ 适用门厚: 38-50mm  
Door Thickness: 38-50mm
- ⑦ 适配锁体: 8550/7255  
Lock body: 8550/7255
- ⑧ 适用范围: 户外门、大门、别墅门、房门  
Available For: Doors Inside And Outside The House And Gate
- ⑨ 适用标准: QB/T2474-2000 GB21556-2008  
Applicable Standard: QB/T2474-2000 GB21556-2008

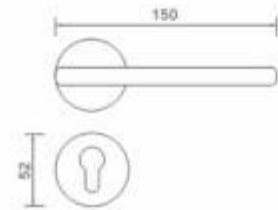

**A5-988 PVD •**



**A5-988 DSN •**



**A5-814 PVD •**

- ④ 表面处理: 镀金  
Finish: PVD
- ⑤ 材质: 锌合金  
Material: Zinc Alloy
- ⑥ 适用门厚: 38-50mm  
Door Thickness: 38-50mm
- ⑦ 适配锁体: 8550/7255  
Lock body: 8550/7255
- ⑧ 适用范围: 户外门、大门、别墅门、房门  
Available For: Doors Inside And Outside The House And Gate
- ⑨ 适用标准: QB/T2474-2000 GB21556-2008  
Applicable Standard: QB/T2474-2000 GB21556-2008

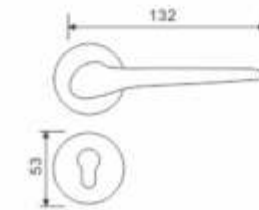

**A5-814 CP •**



**A5-814 BL •**



**A5-908 BL •**

- ④ 表面处理: 哑黑  
Finish: BL
- ⑤ 材质: 锌合金  
Material: Zinc Alloy
- ⑥ 适用门厚: 38-50mm  
Door Thickness: 38-50mm
- ⑦ 适配锁体: 8550/7255  
Lock body: 8550/7255
- ⑧ 适用范围: 户外门、大门、别墅门、房门  
Available For: Doors Inside And Outside The House And Gate
- ⑨ 适用标准: QB/T2474-2000 GB21556-2008  
Applicable Standard: QB/T2474-2000 GB21556-2008

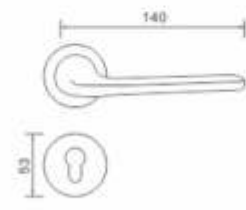

**A5-908 DSN •**



**A5-908 COF •**



**A5-937 BL •**

- ④ 表面处理: 哑黑  
Finish: BL
- ⑤ 材质: 锌合金  
Material: Zinc Alloy
- ⑥ 适用门厚: 38-50mm  
Door Thickness: 38-50mm
- ⑦ 适配锁体: 8550/7255  
Lock body: 8550/7255
- ⑧ 适用范围: 户外门、大门、别墅门、房门  
Available For: Doors Inside And Outside The House And Gate
- ⑨ 适用标准: QB/T2474-2000 GB21556-2008  
Applicable Standard: QB/T2474-2000 GB21556-2008

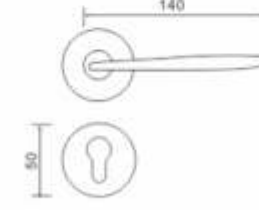

**A5-937 DSN •**



**A5-937 DAB •**



**A5-917 DSN •**

- ④ 表面处理: 哑光镍拉丝  
Finish: DSN
- ⑤ 材质: 锌合金  
Material: Zinc Alloy
- ⑥ 适用门厚: 38-50mm  
Door Thickness: 38-50mm
- ⑦ 适配锁体: 8550/7255  
Lock body: 8550/7255
- ⑧ 适用范围: 户外门、大门、别墅门、房门  
Available For: Doors Inside And Outside The House And Gate
- ⑨ 适用标准: QB/T2474-2000 GB21556-2008  
Applicable Standards: QB/T2474-2000 GB21556-2008

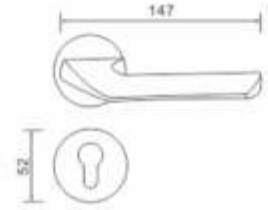

**A5-917 BS •**



**A5-2001 DSN •**

- ④ 表面处理: 哑光镍拉丝  
Finish: DSN
- ⑤ 材质: 锌合金  
Material: Zinc Alloy
- ⑥ 适用门厚: 38-50mm  
Door Thickness: 38-50mm
- ⑦ 适配锁体: 8550/7255  
Lock body: 8550/7255
- ⑧ 适用范围: 户外门、大门、别墅门、房门  
Available For: Doors Inside And Outside The House And Gate
- ⑨ 适用标准: QB/T2474-2000 GB21556-2008  
Applicable Standards: QB/T2474-2000 GB21556-2008

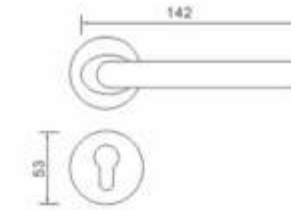

**A5-2001 BS •**



**A5-918 BS •**

- ④ 表面处理: 亮镍拉丝  
Finish: BS
- ⑤ 材质: 锌合金  
Material: Zinc Alloy
- ⑥ 适用门厚: 38-50mm  
Door Thickness: 38-50mm
- ⑦ 适配锁体: 8550/7255  
Lock body: 8550/7255
- ⑧ 适用范围: 户外门、大门、别墅门、房门  
Available For: Doors Inside And Outside The House And Gate
- ⑨ 适用标准: QB/T2474-2000 GB21556-2008  
Applicable Standards: QB/T2474-2000 GB21556-2008

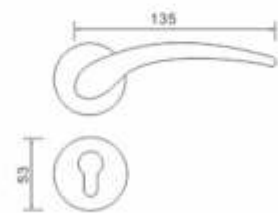

**A5-918 CP •**



**A5-985 BN •**

- ④ 表面处理: 亮黑镍  
Finish: BN
- ⑤ 材质: 锌合金  
Material: Zinc Alloy
- ⑥ 适用门厚: 38-50mm  
Door Thickness: 38-50mm
- ⑦ 适配锁体: 8550/7255  
Lock body: 8550/7255
- ⑧ 适用范围: 户外门、大门、别墅门、房门  
Available For: Doors Inside And Outside The House And Gate
- ⑨ 适用标准: QB/T2474-2000 GB21556-2008  
Applicable Standards: QB/T2474-2000 GB21556-2008

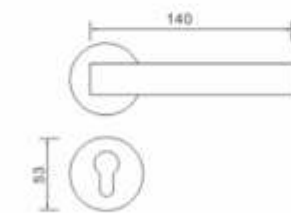

**A5-985 CP •**



**A5-985 PVD •**



**A9-965 BL •**

- ④ 表面处理: 哑黑  
Finish: BL
- ⑤ 材质: 锌合金  
Material: Zinc Alloy
- ⑥ 适用门厚: 38-50mm  
Door Thickness: 38-50mm
- ⑦ 适配锁体: 8550/7255  
Lock body: 8550/7255
- ⑧ 适用范围: 户外门, 大门, 别墅门, 房门  
Available For: Doors Inside And Outside The House And Gate
- ⑨ 适用标准: QB/T2474-2000 GB21556-2008  
Applicable Standards: QB/T2474-2000 GB21556-2008

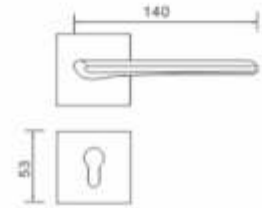

**A5-965 BS •**



**A9-965 DSN •**



**A9-987 BL •**

- ④ 表面处理: 哑黑  
Finish: BL
- ⑤ 材质: 锌合金  
Material: Zinc Alloy
- ⑥ 适用门厚: 38-50mm  
Door Thickness: 38-50mm
- ⑦ 适配锁体: 8550/7255  
Lock body: 8550/7255
- ⑧ 适用范围: 户外门, 大门, 别墅门, 房门  
Available For: Doors Inside And Outside The House And Gate
- ⑨ 适用标准: QB/T2474-2000 GB21556-2008  
Applicable Standards: QB/T2474-2000 GB21556-2008

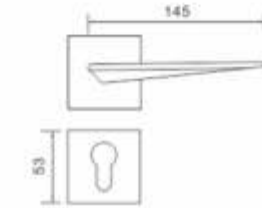

**A9-987 DSN •**



**A9-987 PVD •**



**A9-940 BL •**

- ④ 表面处理: 哑黑  
Finish: BL
- ⑤ 材质: 锌合金  
Material: Zinc Alloy
- ⑥ 适用门厚: 38-50mm  
Door Thickness: 38-50mm
- ⑦ 适配锁体: 8550/7255  
Lock body: 8550/7255
- ⑧ 适用范围: 户外门, 大门, 别墅门, 房门  
Available For: Doors Inside And Outside The House And Gate
- ⑨ 适用标准: QB/T2474-2000 GB21556-2008  
Applicable Standards: QB/T2474-2000 GB21556-2008

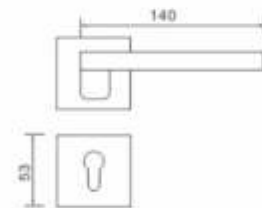

**A9-940 BS •**



**A9-940 DSN •**



**A9-992 COF •**

- ④ 表面处理: 黄古铜  
Finish: COF
- ⑤ 材质: 锌合金  
Material: Zinc Alloy
- ⑥ 适用门厚: 38-50mm  
Door Thickness: 38-50mm
- ⑦ 适配锁体: 8550/7255  
Lock body: 8550/7255
- ⑧ 适用范围: 户外门, 大门, 别墅门, 房门  
Available For: Doors Inside And Outside The House And Gate
- ⑨ 适用标准: QB/T2474-2000 GB21556-2008  
Applicable Standards: QB/T2474-2000 GB21556-2008

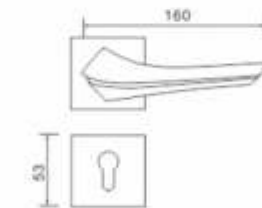

**A9-992 DSN •**



**A9-992 BS •**



**A9-766 BL •**

- ④ 表面处理: 亚黑  
Finish: BL
- ⑤ 材质: 锌合金  
Material: Zinc Alloy
- ⑥ 适用门厚: 38-50mm  
Door Thickness: 38-50mm
- ⑦ 适配锁体: 8550/7255  
Lock body: 8550/7255
- ⑧ 适用范围: 户外门、大门、别墅门、房门  
Available For: Doors Inside And Outside The House And Gate
- ⑨ 适用标准: QB/T2474-2000 GB21556-2008  
Applicable Standard: QB/T2474-2000 GB21556-2008

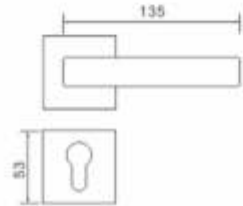

**A9-766 CP •**



**A9-766 SN •**



**A9-953 COF •**

- ④ 表面处理: 黄古铜  
Finish: COF
- ⑤ 材质: 锌合金  
Material: Zinc Alloy
- ⑥ 适用门厚: 38-50mm  
Door Thickness: 38-50mm
- ⑦ 适配锁体: 8550/7255  
Lock body: 8550/7255
- ⑧ 适用范围: 户外门、大门、别墅门、房门  
Available For: Doors Inside And Outside The House And Gate
- ⑨ 适用标准: QB/T2474-2000 GB21556-2008  
Applicable Standard: QB/T2474-2000 GB21556-2008

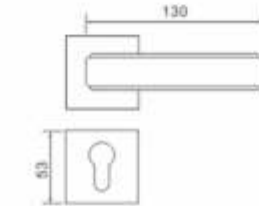

**A9-953 BL •**



**A9-953 DSN •**



**A9-938 BL •**

- ④ 表面处理: 哑黑  
Finish: BL
- ⑤ 材质: 锌合金  
Material: Zinc Alloy
- ⑥ 适用门厚: 38-50mm  
Door Thickness: 38-50mm
- ⑦ 适配锁体: 8550/7255  
Lock body: 8550/7255
- ⑧ 适用范围: 户外门、大门、别墅门、房门  
Available For: Doors Inside And Outside The House And Gate
- ⑨ 适用标准: QB/T2474-2000 GB21556-2008  
Applicable Standard: QB/T2474-2000 GB21556-2008

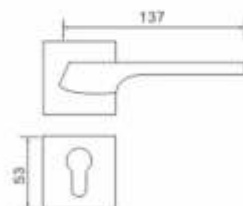

**A5-938 BL •**



**A9-933 BS •**

- ④ 表面处理: 美国拉丝  
Finish: BS
- ⑤ 材质: 锌合金  
Material: Zinc Alloy
- ⑥ 适用门厚: 38-50mm  
Door Thickness: 38-50mm
- ⑦ 适配锁体: 8550/7255  
Lock body: 8550/7255
- ⑧ 适用范围: 户外门、大门、别墅门、房门  
Available For: Doors Inside And Outside The House And Gate
- ⑨ 适用标准: QB/T2474-2000 GB21556-2008  
Applicable Standard: QB/T2474-2000 GB21556-2008

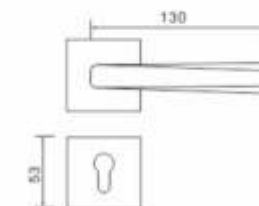

**A9-933 DSN •**



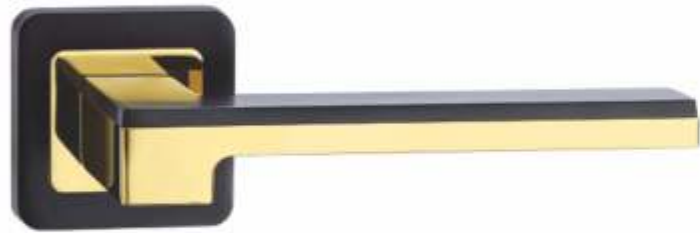

### A25-880 BL/PVD •

- ④ 表面处理: 亚黑/镀金  
Finish: BL/PVD
- ⑤ 材质: 锌合金  
Material: Zinc Alloy
- ⑥ 适用门厚: 38-50mm  
Door Thickness: 38-50mm
- ⑦ 适配锁体: 8550/7255  
Lock body: 8550/7255
- ⑧ 适用范围: 户外门、大门、别墅门、房门  
Available For: Doors Inside And Outside The House And Gate
- ⑨ 适用标准: QB/T2474-2000 GB21556-2008  
Applicable Standard: QB/T2474-2000 GB21556-2008

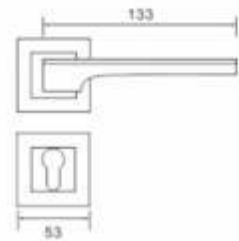

### A25-880 BL/CP •



### A25-811 BL/CP •

- ④ 表面处理: 亚黑/镀铬  
Finish: BL/CP
- ⑤ 材质: 锌合金  
Material: Zinc Alloy
- ⑥ 适用门厚: 38-50mm  
Door Thickness: 38-50mm
- ⑦ 适配锁体: 8550/7255  
Lock body: 8550/7255
- ⑧ 适用范围: 户外门、大门、别墅门、房门  
Available For: Doors Inside And Outside The House And Gate
- ⑨ 适用标准: QB/T2474-2000 GB21556-2008  
Applicable Standard: QB/T2474-2000 GB21556-2008

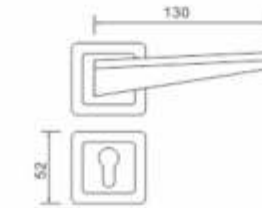

### A25-811 BS/CP •



### A25-811 SN/CP •



### A25-745 BL/CP •

- ④ 表面处理: 亚黑/镀铬  
Finish: BL/CP
- ⑤ 材质: 锌合金  
Material: Zinc Alloy
- ⑥ 适用门厚: 38-50mm  
Door Thickness: 38-50mm
- ⑦ 适配锁体: 8550/7255  
Lock body: 8550/7255
- ⑧ 适用范围: 户外门、大门、别墅门、房门  
Available For: Doors Inside And Outside The House And Gate
- ⑨ 适用标准: QB/T2474-2000 GB21556-2008  
Applicable Standard: QB/T2474-2000 GB21556-2008

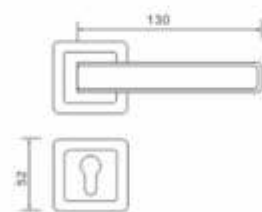

### A25-745 PC/CP •



### A25-745 COF •



### A25-813 BS/CP •

- ④ 表面处理: 黑镍拉丝/镀铬  
Finish: BS/CP
- ⑤ 材质: 锌合金  
Material: Zinc Alloy
- ⑥ 适用门厚: 38-50mm  
Door Thickness: 38-50mm
- ⑦ 适配锁体: 8550/7255  
Lock body: 8550/7255
- ⑧ 适用范围: 户外门、大门、别墅门、房门  
Available For: Doors Inside And Outside The House And Gate
- ⑨ 适用标准: QB/T2474-2000 GB21556-2008  
Applicable Standard: QB/T2474-2000 GB21556-2008

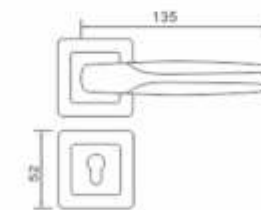

### A25-813 BL/CP •



### A25-813 SN/CP •



### A-618 SN/CP •

- ④ 表面处理: 镍拉丝/镀铬  
Finish: SN/CP
- ⑤ 材质: 锌合金  
Material: Zinc Alloy
- ⑥ 适用门厚: 38-50mm  
Door Thickness: 38-50mm
- ⑦ 适配锁体: 8550/7255  
Lock body: 8550/7255
- ⑧ 适用范围: 户外门、大门、别墅门、房门  
Available For: Doors Inside And Outside The House And Gate
- ⑨ 适用标准: QB/T2474-2000 GB21556-2008  
Applicable Standard: QB/T2474-2000 GB21556-2008

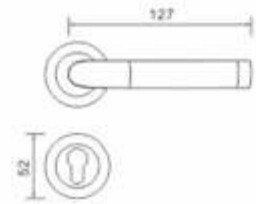

### A-618 BL/CP •



### A25-879 BL/CP •

- ④ 表面处理: 亚黑/镀铬  
Finish: BL/CP
- ⑤ 材质: 锌合金  
Material: Zinc Alloy
- ⑥ 适用门厚: 38-50mm  
Door Thickness: 38-50mm
- ⑦ 适配锁体: 8550/7255  
Lock body: 8550/7255
- ⑧ 适用范围: 户外门、大门、别墅门、房门  
Available For: Doors Inside And Outside The House And Gate
- ⑨ 适用标准: QB/T2474-2000 GB21556-2008  
Applicable Standard: QB/T2474-2000 GB21556-2008

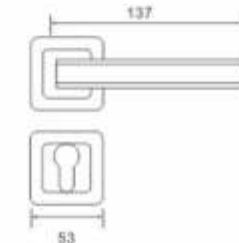

### A25-879 BL/PVD •



### A5-909 BL/CP •

- ④ 表面处理: 亚黑/镀铬  
Finish: BL/CP
- ⑤ 材质: 锌合金  
Material: Zinc Alloy
- ⑥ 适用门厚: 38-50mm  
Door Thickness: 38-50mm
- ⑦ 适配锁体: 8550/7255  
Lock body: 8550/7255
- ⑧ 适用范围: 户外门、大门、别墅门、房门  
Available For: Doors Inside And Outside The House And Gate
- ⑨ 适用标准: QB/T2474-2000 GB21556-2008  
Applicable Standard: QB/T2474-2000 GB21556-2008

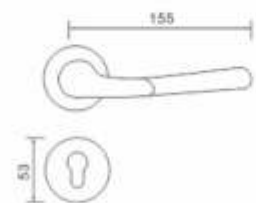

### A5-909 W/CP •



### A9-910 SN/CP •

- ④ 表面处理: 镍拉丝/镀铬  
Finish: SN/CP
- ⑤ 材质: 锌合金  
Material: Zinc Alloy
- ⑥ 适用门厚: 38-50mm  
Door Thickness: 38-50mm
- ⑦ 适配锁体: 8550/7255  
Lock body: 8550/7255
- ⑧ 适用范围: 户外门、大门、别墅门、房门  
Available For: Doors Inside And Outside The House And Gate
- ⑨ 适用标准: QB/T2474-2000 GB21556-2008  
Applicable Standard: QB/T2474-2000 GB21556-2008

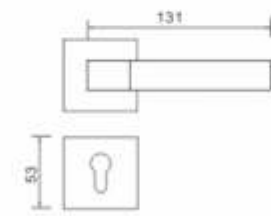

### A9-910 BL/CP •



### A9-910 BS/CP •



### A5-704 BL •

- ④ 表面处理: 亚黑  
Finish: BL
- ① 材质: 锌合金  
Material: Zinc Alloy
- ② 适用门厚: 38-50mm  
Door Thickness: 38-50mm
- ③ 适配锁体: 8550/7255  
Lock body: 8550/7255
- ⑧ 适用范围: 户外门、大门、别墅门、房门  
Available For: Doors Inside And Outside The House And Gate
- ⑨ 适用标准: QB/T2474-2000 GB21556-2008  
Applicable Standard: QB/T2474-2000 GB21556-2008

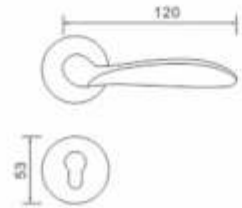

### A5-704 PVD •



### A5-704 DSN •



### A5-592 SN •

- ④ 表面处理: 拉丝银  
Finish: SN
- ① 材质: 锌合金  
Material: Zinc Alloy
- ② 适用门厚: 38-50mm  
Door Thickness: 38-50mm
- ③ 适配锁体: 8550/7255  
Lock body: 8550/7255
- ⑧ 适用范围: 户外门、大门、别墅门、房门  
Available For: Doors Inside And Outside The House And Gate
- ⑨ 适用标准: QB/T2474-2000 GB21556-2008  
Applicable Standard: QB/T2474-2000 GB21556-2008

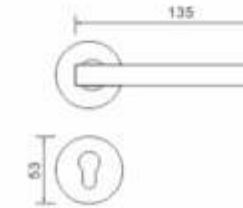

### A5-592 BL •



### A5-559 BL •

- ④ 表面处理: 亚黑  
Finish: BL
- ① 材质: 锌合金  
Material: Zinc Alloy
- ② 适用门厚: 38-50mm  
Door Thickness: 38-50mm
- ③ 适配锁体: 8550/7255  
Lock body: 8550/7255
- ⑧ 适用范围: 户外门、大门、别墅门、房门  
Available For: Doors Inside And Outside The House And Gate
- ⑨ 适用标准: QB/T2474-2000 GB21556-2008  
Applicable Standard: QB/T2474-2000 GB21556-2008

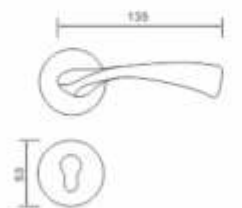

### A5-559 BS •



### A5-559 DAB •



### A5-592 PVD •

- ④ 表面处理: 镀金  
Finish: PVD
- ① 材质: 锌合金  
Material: Zinc Alloy
- ② 适用门厚: 38-50mm  
Door Thickness: 38-50mm
- ③ 适配锁体: 8550/7255  
Lock body: 8550/7255
- ⑧ 适用范围: 户外门、大门、别墅门、房门  
Available For: Doors Inside And Outside The House And Gate
- ⑨ 适用标准: QB/T2474-2000 GB21556-2008  
Applicable Standard: QB/T2474-2000 GB21556-2008

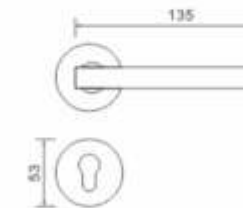

### A5-592 BS •



### A5-749 PVD •

- ④ 表面处理: 镀金  
Finish: PVD
- ⑤ 材质: 锌合金  
Material: Zinc Alloy
- ⑥ 适用门厚: 38-50mm  
Door Thickness: 38-50mm
- ⑦ 适配锁体: 8550/7255  
Lock body: 8550/7255
- ⑧ 适用范围: 户外门、大门、别墅门、房门  
Available For: Doors Inside And Outside The House And Gate
- ⑨ 适用标准: QB/T2474-2000 GB21556-2008  
Applicable Standard: QB/T2474-2000 GB21556-2008

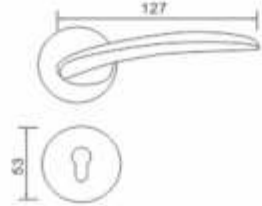

A5-749 CP •



### A5-746 PVD •

- ④ 表面处理: 镀金  
Finish: PVD
- ⑤ 材质: 锌合金  
Material: Zinc Alloy
- ⑥ 适用门厚: 38-50mm  
Door Thickness: 38-50mm
- ⑦ 适配锁体: 8550/7255  
Lock body: 8550/7255
- ⑧ 适用范围: 户外门、大门、别墅门、房门  
Available For: Doors Inside And Outside The House And Gate
- ⑨ 适用标准: QB/T2474-2000 GB21556-2008  
Applicable Standard: QB/T2474-2000 GB21556-2008

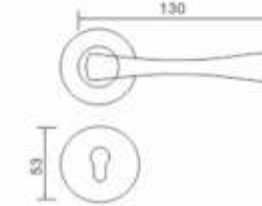

A5-746 CP •



### A5-897 CP •

- ④ 表面处理: 镀镍  
Finish: CP
- ⑤ 材质: 锌合金  
Material: Zinc Alloy
- ⑥ 适用门厚: 38-50mm  
Door Thickness: 38-50mm
- ⑦ 适配锁体: 8550/7255  
Lock body: 8550/7255
- ⑧ 适用范围: 户外门、大门、别墅门、房门  
Available For: Doors Inside And Outside The House And Gate
- ⑨ 适用标准: QB/T2474-2000 GB21556-2008  
Applicable Standard: QB/T2474-2000 GB21556-2008

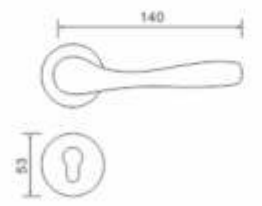

A5-897 PVD •



A5-897 DSN •



### A5-594 CP •

- ④ 表面处理: 镀镍  
Finish: CP
- ⑤ 材质: 锌合金  
Material: Zinc Alloy
- ⑥ 适用门厚: 38-50mm  
Door Thickness: 38-50mm
- ⑦ 适配锁体: 8550/7255  
Lock body: 8550/7255
- ⑧ 适用范围: 户外门、大门、别墅门、房门  
Available For: Doors Inside And Outside The House And Gate
- ⑨ 适用标准: QB/T2474-2000 GB21556-2008  
Applicable Standard: QB/T2474-2000 GB21556-2008

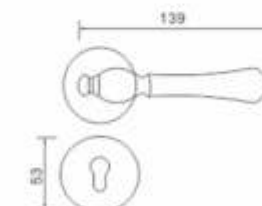

A5-594 PVD •





### A-666 PVD

- ④ 表面处理: 镀金  
Finish: PVD
- ⑤ 材质: 锌合金  
Material: Zinc Alloy
- ⑥ 适用门厚: 38-50mm  
Door Thickness: 38-50mm
- ⑦ 适配锁体: 8550/7255  
Lock body: 8550/7255
- ⑧ 适用范围: 户外门, 大门, 别墅门, 房门  
Available For: Doors Inside And Outside The House And Gate
- ⑨ 适用标准: QB/T2474-2000 GB21556-2008  
Applicable Standards: QB/T2474-2000 GB21556-2008

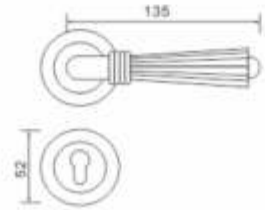

### A-666 CP/BL



### A-666 BL/PVD



### A5-979 BL

- ④ 表面处理: 亚黑  
Finish: BL
- ⑤ 材质: 锌合金  
Material: Zinc Alloy
- ⑥ 适用门厚: 38-50mm  
Door Thickness: 38-50mm
- ⑦ 适配锁体: 8550/7255  
Lock body: 8550/7255
- ⑧ 适用范围: 户外门, 大门, 别墅门, 房门  
Available For: Doors Inside And Outside The House And Gate
- ⑨ 适用标准: QB/T2474-2000 GB21556-2008  
Applicable Standards: QB/T2474-2000 GB21556-2008

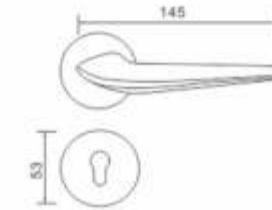

### A5-979 DSN



### A5-979 BS



### A28-878 DAB

- ④ 表面处理: 青古铜  
Finish: DAB
- ⑤ 材质: 锌合金  
Material: Zinc Alloy
- ⑥ 适用门厚: 38-50mm  
Door Thickness: 38-50mm
- ⑦ 适配锁体: 8550/7255  
Lock body: 8550/7255
- ⑧ 适用范围: 户外门, 大门, 别墅门, 房门  
Available For: Doors Inside And Outside The House And Gate
- ⑨ 适用标准: QB/T2474-2000 GB21556-2008  
Applicable Standards: QB/T2474-2000 GB21556-2008



### A28-878 ORC



### A5-928 PVD

- ④ 表面处理: 镀金  
Finish: PVD
- ⑤ 材质: 锌合金  
Material: Zinc Alloy
- ⑥ 适用门厚: 38-50mm  
Door Thickness: 38-50mm
- ⑦ 适配锁体: 8550/7255  
Lock body: 8550/7255
- ⑧ 适用范围: 户外门, 大门, 别墅门, 房门  
Available For: Doors Inside And Outside The House And Gate
- ⑨ 适用标准: QB/T2474-2000 GB21556-2008  
Applicable Standards: QB/T2474-2000 GB21556-2008

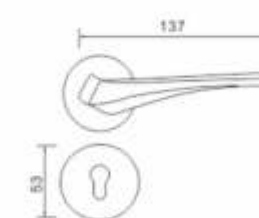

### A5-928 BS



**A9-977 PVD •**

- ④ 表面处理: 镀金  
Finish: PVD
- ⑤ 材质: 锌合金  
Material: Zinc Alloy
- ⑥ 适用门厚: 38-50mm  
Door Thickness: 38-50mm
- ⑦ 适配锁体: 8550/7255  
Lock body: 8550/7255
- ⑧ 适用范围: 户内门、大门、别墅门、房门  
Available For: Doors Inside And Outside The House And Gate
- ⑨ 适用标准: QB/T2474-2000 GB21556-2008  
Applicable Standards: QB/T2474-2000 GB21556-2008

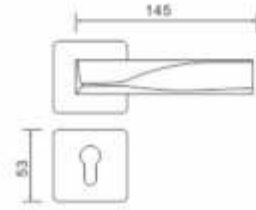

**A9-977 BL •**



**A9-977 DSN •**



**A9-931 CP •**

- ④ 表面处理: 镀铬  
Finish: CP
- ⑤ 材质: 锌合金  
Material: Zinc Alloy
- ⑥ 适用门厚: 38-50mm  
Door Thickness: 38-50mm
- ⑦ 适配锁体: 8550/7255  
Lock body: 8550/7255
- ⑧ 适用范围: 户内门、大门、别墅门、房门  
Available For: Doors Inside And Outside The House And Gate
- ⑨ 适用标准: QB/T2474-2000 GB21556-2008  
Applicable Standards: QB/T2474-2000 GB21556-2008

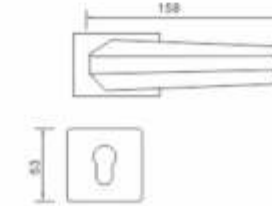

**A9-931 PVD •**



**A9-926 PVD •**

- ④ 表面处理: 镀金  
Finish: PVD
- ⑤ 材质: 锌合金  
Material: Zinc Alloy
- ⑥ 适用门厚: 38-50mm  
Door Thickness: 38-50mm
- ⑦ 适配锁体: 8550/7255  
Lock body: 8550/7255
- ⑧ 适用范围: 户内门、大门、别墅门、房门  
Available For: Doors Inside And Outside The House And Gate
- ⑨ 适用标准: QB/T2474-2000 GB21556-2008  
Applicable Standards: QB/T2474-2000 GB21556-2008

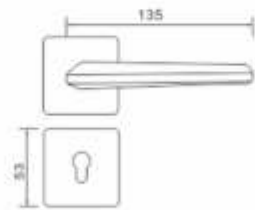

**A9-926 DSN •**



**A9-921 DSN •**

- ④ 表面处理: 吸光镀铬  
Finish: DSN
- ⑤ 材质: 锌合金  
Material: Zinc Alloy
- ⑥ 适用门厚: 38-50mm  
Door Thickness: 38-50mm
- ⑦ 适配锁体: 8550/7255  
Lock body: 8550/7255
- ⑧ 适用范围: 户内门、大门、别墅门、房门  
Available For: Doors Inside And Outside The House And Gate
- ⑨ 适用标准: QB/T2474-2000 GB21556-2008  
Applicable Standards: QB/T2474-2000 GB21556-2008

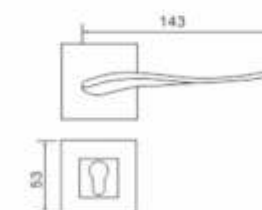

**A9-921 SC •**



### A9-653 RGS •

- ④ 表面处理: 金拉丝  
Finish: RGS
- ⑤ 材质: 锌合金  
Material: Zinc Alloy
- ⑥ 适用门厚: 38-50mm  
Door Thickness: 38-50mm
- ⑦ 适配锁体: 8550/7255  
Lock body: 8550/7255
- ⑧ 适用范围: 户外门, 大门, 别墅门, 房门  
Available For: Doors Inside And Outside The House And Gate
- ⑨ 适用标准: QB/T2474-2000 GB21556-2008  
Applicable Standard: QB/T2474-2000 GB21556-2008

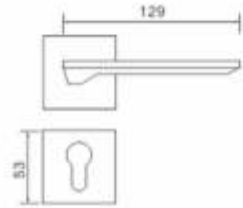

### A9-653 BS •



### A9-653 BL •



### A9-935 PVD •

- ④ 表面处理: 镀金  
Finish: PVD
- ⑤ 材质: 锌合金  
Material: Zinc Alloy
- ⑥ 适用门厚: 38-50mm  
Door Thickness: 38-50mm
- ⑦ 适配锁体: 8550/7255  
Lock body: 8550/7255
- ⑧ 适用范围: 户外门, 大门, 别墅门, 房门  
Available For: Doors Inside And Outside The House And Gate
- ⑨ 适用标准: QB/T2474-2000 GB21556-2008  
Applicable Standard: QB/T2474-2000 GB21556-2008

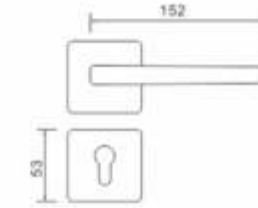

### A9-935 DSN •



### A5-933 BS •

- ④ 表面处理: 黑镍拉丝  
Finish: BS
- ⑤ 材质: 锌合金  
Material: Zinc Alloy
- ⑥ 适用门厚: 38-50mm  
Door Thickness: 38-50mm
- ⑦ 适配锁体: 8550/7255  
Lock body: 8550/7255
- ⑧ 适用范围: 户外门, 大门, 别墅门, 房门  
Available For: Doors Inside And Outside The House And Gate
- ⑨ 适用标准: QB/T2474-2000 GB21556-2008  
Applicable Standard: QB/T2474-2000 GB21556-2008

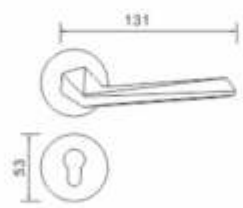

### A5-933 CP •



### A9-934 DSN •

- ④ 表面处理: 抛光镍拉丝  
Finish: DSN
- ⑤ 材质: 锌合金  
Material: Zinc Alloy
- ⑥ 适用门厚: 38-50mm  
Door Thickness: 38-50mm
- ⑦ 适配锁体: 8550/7255  
Lock body: 8550/7255
- ⑧ 适用范围: 户外门, 大门, 别墅门, 房门  
Available For: Doors Inside And Outside The House And Gate
- ⑨ 适用标准: QB/T2474-2000 GB21556-2008  
Applicable Standard: QB/T2474-2000 GB21556-2008

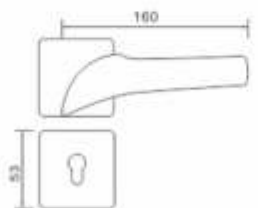

### A9-934 PVD •



**A-554 SN**

- ④ 表面处理: 镍拉丝  
Finish: SN
- ⑤ 材质: 锌合金  
Material: Zinc Alloy
- ⑥ 适用门厚: 38-50mm  
Door Thickness: 38-50mm
- ⑦ 适配锁体: 8550/7255  
Lock body: 8550/7255
- ⑧ 适用范围: 户内门、大门、别墅门、房门  
Available For: Doors Inside And Outside The House And Gate
- ⑨ 适用标准: QB/T2474-2000 GB21556-2008  
Applicable Standard: QB/T2474-2000 GB21556-2008

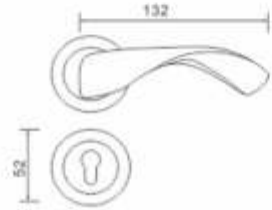

**A-554 PVD**



**A-554 DAB**

**A9-748 PVD**

- ④ 表面处理: 镀金  
Finish: PVD
- ⑤ 材质: 锌合金  
Material: Zinc Alloy
- ⑥ 适用门厚: 38-50mm  
Door Thickness: 38-50mm
- ⑦ 适配锁体: 8550/7255  
Lock body: 8550/7255
- ⑧ 适用范围: 户内门、大门、别墅门、房门  
Available For: Doors Inside And Outside The House And Gate
- ⑨ 适用标准: QB/T2474-2000 GB21556-2008  
Applicable Standard: QB/T2474-2000 GB21556-2008

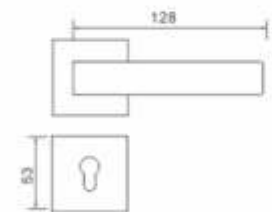

**A9-748 CP**



**A9-748 ORB**

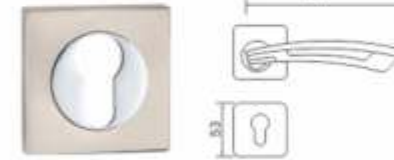

**A7-633 SN/CP/B**



**A-614 BL/CP**



**A55-562 SN/CP**



**A9-775 BL/CP**



**A3-912 COF**



**A2-524 COF**



**A5-528 SN/CP •**



**A9-634 SN/CP/BL •**



**A2-532 ORB •**



**A2-675 ORB •**

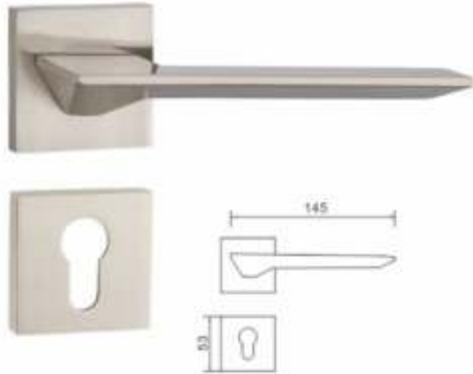

**A9-653 SN •**

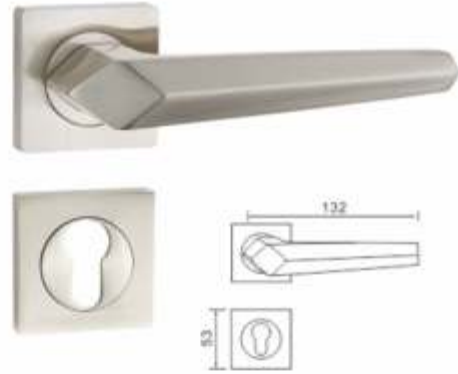

**A7-685 SN •**



**A5-904 BL/C •**

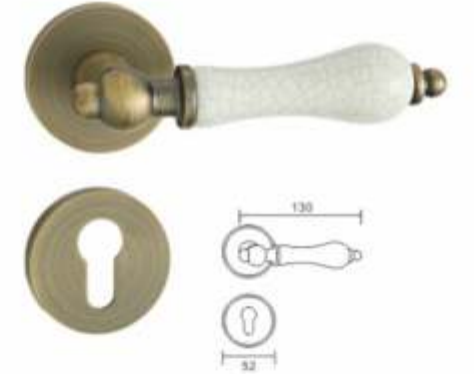

**A5-905 DAB/CR •**

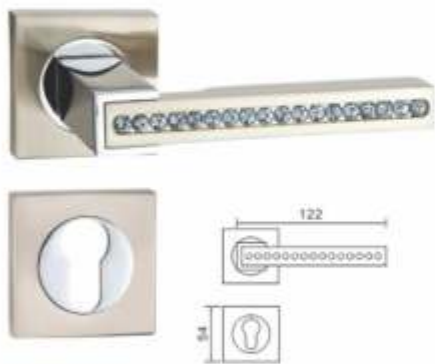

**A7-651 SN/CP/CW •**

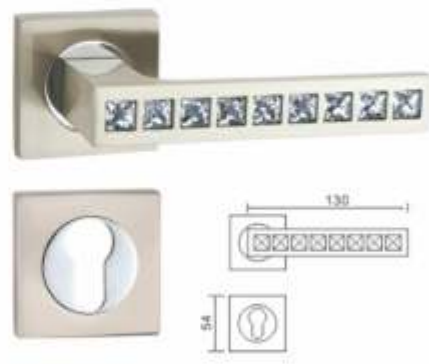

**A7-652 SN/CP/CW •**



**A-801 DSN •**



**A3-525 DAB •**

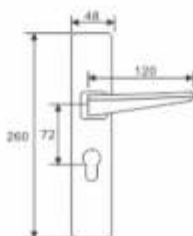

### 72181-811 DSN/CP •

- ④ 表面处理: 亚光拉丝/镀铬  
Finish: DSN/CP
- ⑤ 材质: 锌合金  
Material: Zinc Alloy
- ⑥ 适用门厚: 38-50mm  
Door Thickness: 38-50mm
- ⑦ 适配锁体: 8550/7255  
Lock body: 8550/7255
- ⑧ 适用范围: 户内门、大门、别墅门、房门  
Available For: Doors Inside And Outside The House And Gate
- ⑨ 适用标准: QB/T2474-2000 GB21556-2008  
Applicable Standard: QB/T2474-2000 GB21556-2008



**72181-811 BS/CP •**  
表面处理: 亚光拉丝/镀铬

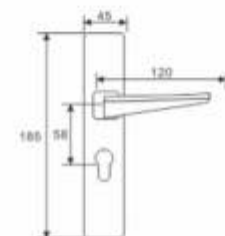

### 58181-811 DSN/CP •

- ④ 表面处理: 亚光拉丝/镀铬  
Finish: DSN/CP
- ⑤ 材质: 锌合金  
Material: Zinc Alloy
- ⑥ 适用门厚: 38-50mm  
Door Thickness: 38-50mm
- ⑦ 适配锁体: 8550/7255  
Lock body: 8550/7255
- ⑧ 适用范围: 户内门、大门、别墅门、房门  
Available For: Doors Inside And Outside The House And Gate
- ⑨ 适用标准: QB/T2474-2000 GB21556-2008  
Applicable Standard: QB/T2474-2000 GB21556-2008



**58181-811 BS/CP •**  
表面处理: 亚光拉丝/镀铬

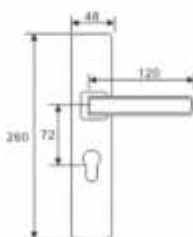

### 72181-745 DSN/CP •

- ④ 表面处理: 亚光拉丝/镀铬  
Finish: DSN/CP
- ⑤ 材质: 锌合金  
Material: Zinc Alloy
- ⑥ 适用门厚: 38-50mm  
Door Thickness: 38-50mm
- ⑦ 适配锁体: 8550/7255  
Lock body: 8550/7255
- ⑧ 适用范围: 户内门、大门、别墅门、房门  
Available For: Doors Inside And Outside The House And Gate
- ⑨ 适用标准: QB/T2474-2000 GB21556-2008  
Applicable Standard: QB/T2474-2000 GB21556-2008



**72181-745 BS/CP •**  
表面处理: 亚光拉丝/镀铬

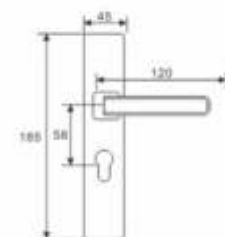

### 58181-745 DSN/CP •

- ④ 表面处理: 亚光拉丝/镀铬  
Finish: DSN/CP
- ⑤ 材质: 锌合金  
Material: Zinc Alloy
- ⑥ 适用门厚: 38-50mm  
Door Thickness: 38-50mm
- ⑦ 适配锁体: 8550/7255  
Lock body: 8550/7255
- ⑧ 适用范围: 户内门、大门、别墅门、房门  
Available For: Doors Inside And Outside The House And Gate
- ⑨ 适用标准: QB/T2474-2000 GB21556-2008  
Applicable Standard: QB/T2474-2000 GB21556-2008



**58181-745 BS/CP •**  
表面处理: 亚光拉丝/镀铬



**8534-525 DAB •**

- ④ 表面处理: 青古铜  
Finish: DAB
- ⑤ 材质: 锌合金  
Material: Zinc Alloy
- ⑥ 适用门厚: 38-50mm  
Door Thickness: 38-50mm
- ⑦ 适配锁体: 8550  
Install the door so from: 8550
- ⑧ 适用范围: 户外门、大门、别墅门  
Available For: Doors Inside And Outside The House And Gate
- ⑨ 适用标准: QB/T2474-2000 QB21556-2008  
Applicable Standard: QB/T2474-2000 QB21556-2008

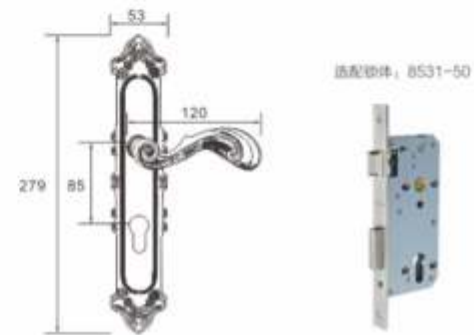

- 可选表面处理 Optinal Finish:
- |         |              |         |
|---------|--------------|---------|
| COF 黄古铜 | PVD 钛金       | DAB 青古铜 |
| DAC 红古铜 | BN/RGP 黑镍/真金 |         |



**8535-526 PVD •**

- ④ 表面处理: 钛金  
Finish: PVD
- ⑤ 材质: 锌合金  
Material: Zinc Alloy
- ⑥ 适用门厚: 38-50mm  
Door Thickness: 38-50mm
- ⑦ 适配锁体: 8550  
Install the door so from: 8550
- ⑧ 适用范围: 户外门、大门、别墅门  
Available For: Doors Inside And Outside The House And Gate
- ⑨ 适用标准: QB/T2474-2000 QB21556-2008  
Applicable Standard: QB/T2474-2000 QB21556-2008

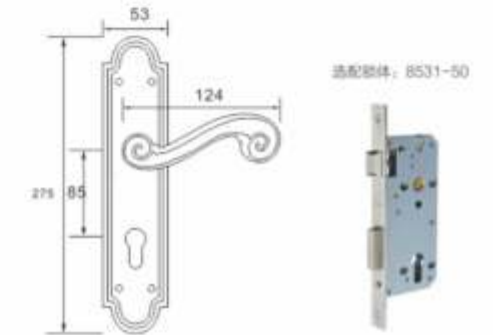

- 可选表面处理 Optinal Finish:
- |         |             |         |
|---------|-------------|---------|
| COF 黄古铜 | PVD 钛金      | DAB 青古铜 |
| DAC 红古铜 | SN/CP 镍拉丝/银 |         |

**5834-525 PVD •**

- ④ 表面处理: 钛金  
Finish: PVD
- ⑤ 材质: 锌合金  
Material: Zinc Alloy
- ⑦ 适配锁体: 5845  
Install the door so from: 5845



**5834-525 DAB •**

- ④ 表面处理: 青古铜  
Finish: DAB
- ⑤ 材质: 锌合金  
Material: Zinc Alloy
- ⑦ 适配锁体: 5845  
Install the door so from: 5845



**5835-526 COF •**

- ④ 表面处理: 黄古铜  
Finish: COF
- ⑤ 材质: 锌合金  
Material: Zinc Alloy
- ⑦ 适配锁体: 5845  
Install the door so from: 5845



**5835-526 PVD •**

- ④ 表面处理: 钛金  
Finish: PVD
- ⑤ 材质: 锌合金  
Material: Zinc Alloy
- ⑦ 适配锁体: 5845  
Install the door so from: 5845

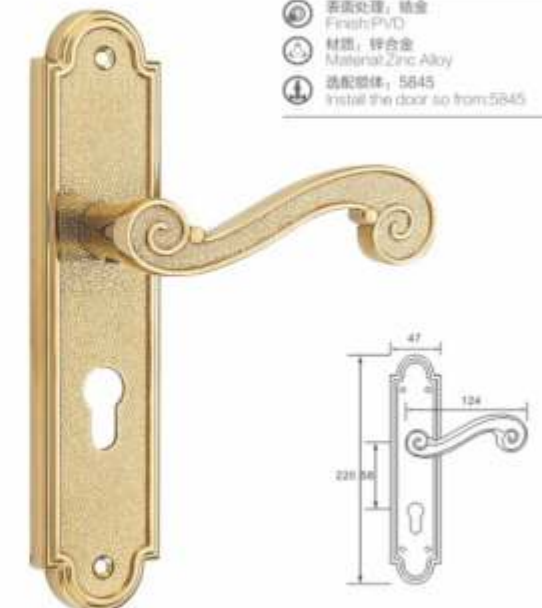



**8536-527 DAB •**

- ④ 表面处理: 青古铜  
Finish: DAB
- ④ 材质: 锌合金  
Material: Zinc Alloy
- ④ 适用门厚: 38-50mm  
Door Thickness: 38-50mm
- ④ 适配锁体: 8550  
Install the door so from: 8550
- ④ 适用范围: 户外门、大门、别墅门  
Available For: Doors Inside And Outside The House And Gate
- ④ 适用标准: QB/T2474-2000 GB21556-2008  
Applicable Standard: QB/T2474-2000 GB21556-2008

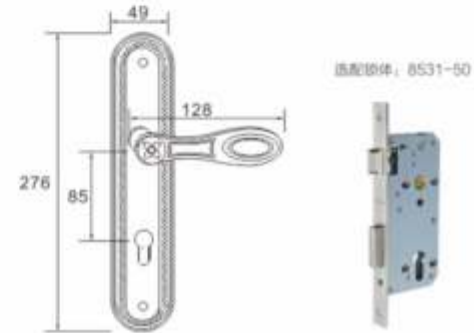

- 可选表面处理 Optinal Finish:
- COF 黑古铜
  - PVD 钛金
  - DAB 青古铜
  - DAC 红古铜
  - SN/CP 镍拉丝枪

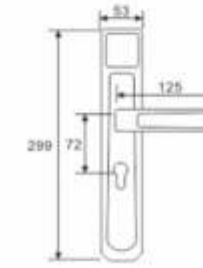

**72131-710 DAB •**

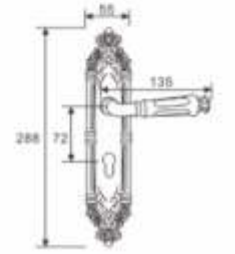
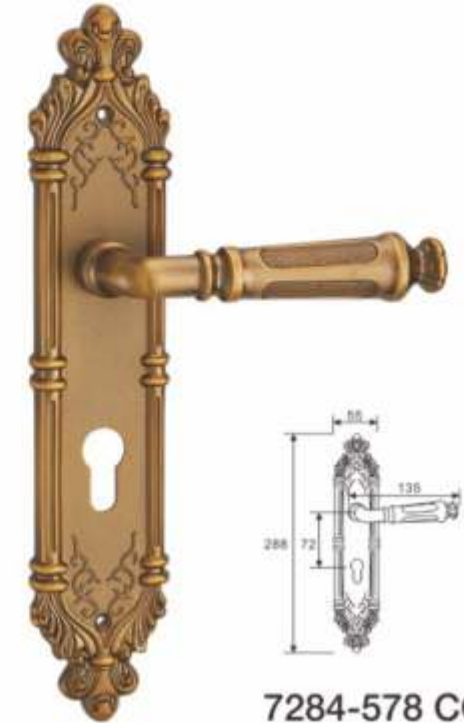

**7284-578 COF •**

**5836-527 PVD •**

- ④ 表面处理: 钛金  
Finish: PVD
- ④ 材质: 锌合金  
Material: Zinc Alloy
- ④ 适配锁体: 5845  
Install the door so from: 5845

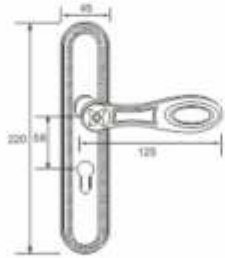

**5836-527 DAB •**

- ④ 表面处理: 青古铜  
Finish: DAB
- ④ 材质: 锌合金  
Material: Zinc Alloy
- ④ 适配锁体: 5845  
Install the door so from: 5845

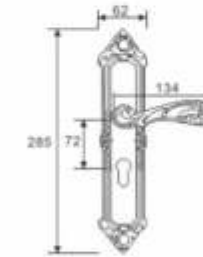
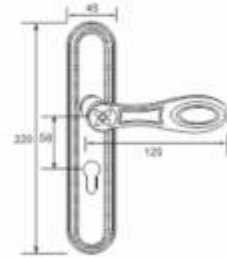
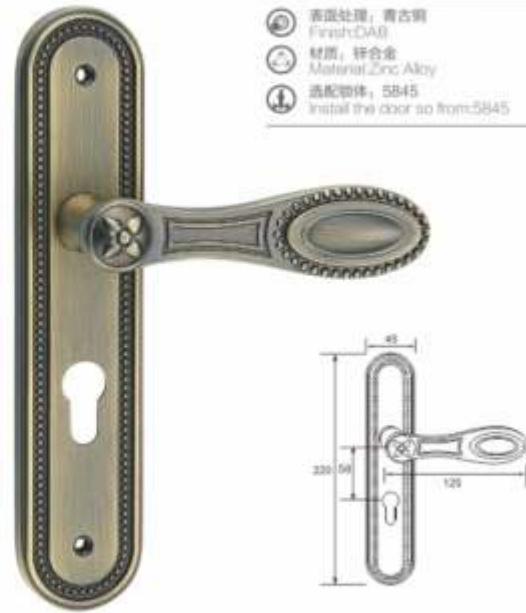

**72133-712 COF •**

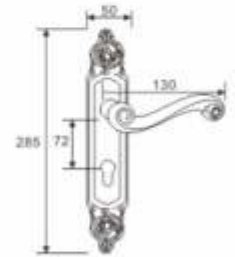
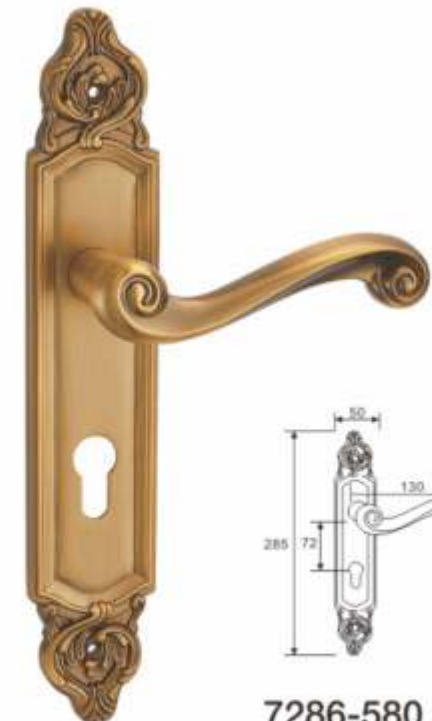

**7286-580 COF •**





5845 防插消音锁体

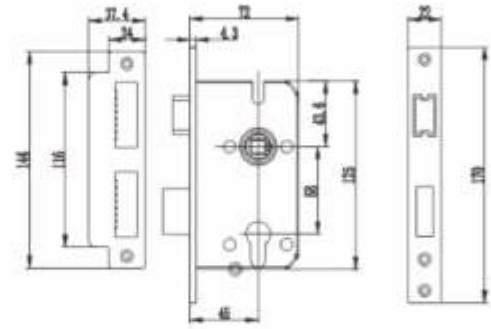

5845 磁力消音锁体

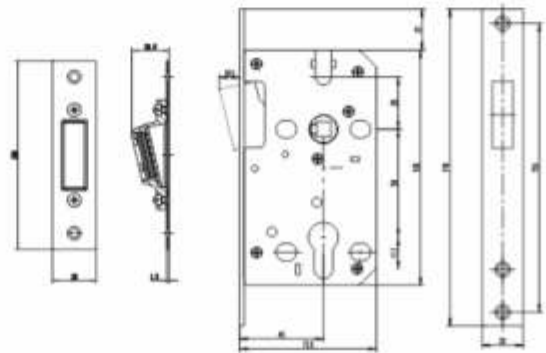

小70系列锁芯

**安装说明 Installation Instruction**

1. 安装锁体，预紧锁体螺钉
  2. 装面板、把手，并预紧螺钉，调整位置，使把手动作正常
  3. 安装锁芯，并预紧锁芯螺钉，转动旋钮和钥匙，确定转动无阻后，紧固锁芯螺钉
  4. 安装扣板，并预紧螺钉，调整位置，达到上锁、开锁自如，调整到最佳状态后，紧固所有螺钉，完成安装。
1. install the lock body and pre-tighten the screws
  2. install the escutcheons and handles, and then pre-tighten the screws; adjust the position to enable the handles move smoothly.
  3. insert the cylinder, pre-tighten the screws; turning the key and knob, ensure them move smoothly and then tighten the screws
  4. install the plastic striking plate, and then pre-tighten the screws; adjust the position to enable lock and unlock smoothly, adjust to the best working condition, and then tighten all screws

**表面处理:** 不锈钢拉丝、钛金拉丝、镍拉丝、青古铜、红古铜  
**Finish:** SS/SPVD/SN/AB/AC  
**主要材质:** 不锈钢、铜、铁、锌  
**Material:** Stainless steel/Brass/iron  
**类型 Features:** 插芯锁体 Mortise Lock  
**技术参数 Technical Data:**  
 1. 拨轮方芯 Laver follower: 8.2x8.2mm  
 2. 中心距 Center Length(A): 58mm  
 3. 门边距 Edge Distance: 45mm  
**配置附件 Accessories:**  
 1. 自攻螺丝 Screws  
 2. 扣板 Striking Plate  
 3. 塑料扣盒 Plastic Strike Box

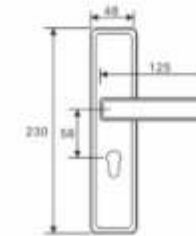

**58172-783 BBF •**

- ④ 表面处理: 富士黑  
Finish: BF
- ④ 材质: 锌合金  
Material: Zinc Alloy
- ④ 适用门厚: 38-50mm  
Door Thickness: 38-50mm
- ④ 适配锁体: 5845  
Lock body: 5845
- ④ 适用标准: QB/T2474-2000 GB21556-2008  
Applicable Standard: QB/T2474-2000 GB21556-2008



58172-783 COF •



58172-783 DAB •

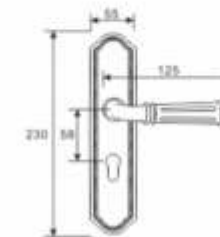
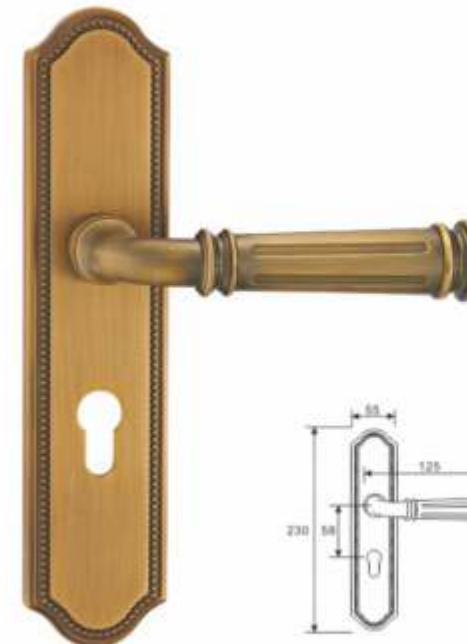

**58177-785 COF •**

- ④ 表面处理: 青古铜  
Finish: COF
- ④ 材质: 锌合金  
Material: Zinc Alloy
- ④ 适用门厚: 38-50mm  
Door Thickness: 38-50mm
- ④ 适配锁体: 5845  
Lock body: 5845
- ④ 适用标准: QB/T2474-2000 GB21556-2008  
Applicable Standard: QB/T2474-2000 GB21556-2008



58177-785 DAB •



58177-785 ORB •

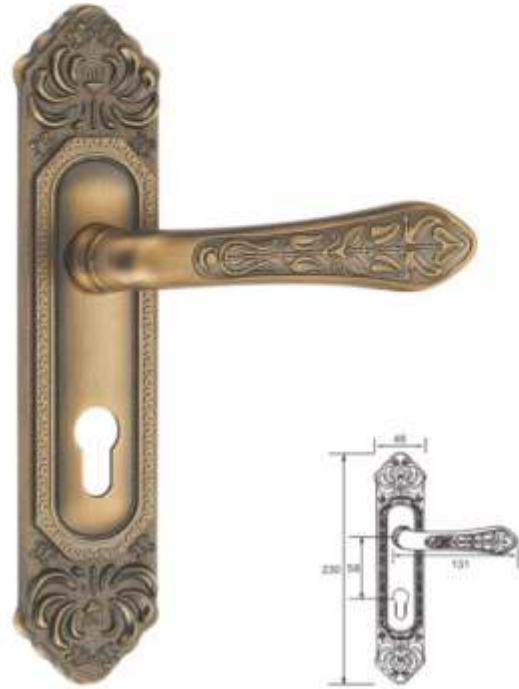

**5833-524 COF •**

- ④ 表面处理: 黄古铜  
Finish: COF
- ④ 材质: 锌合金  
Material: Zinc Alloy
- ④ 适用门厚: 38-50mm  
Door Thickness: 38-50mm
- ④ 适配锁体: 5845  
Lock body: 5845
- ④ 适用标准: QB/T2474-2000 GB21556-2008  
Applicable Standard: QB/T2474-2000 GB21556-2008

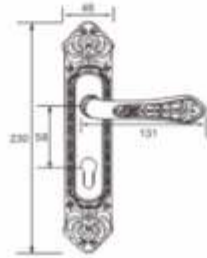

**5833-524 PVD •**

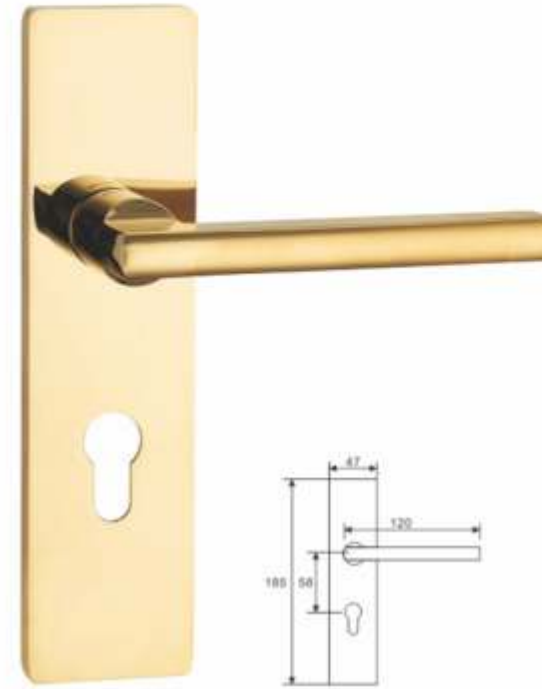

**5881-592 PVD •**

- ④ 表面处理: 铬金  
Finish: PVD
- ④ 材质: 锌合金  
Material: Zinc Alloy
- ④ 适用门厚: 38-50mm  
Door Thickness: 38-50mm
- ④ 适配锁体: 5845  
Lock body: 5845
- ④ 适用标准: QB/T2474-2000 GB21556-2008  
Applicable Standard: QB/T2474-2000 GB21556-2008

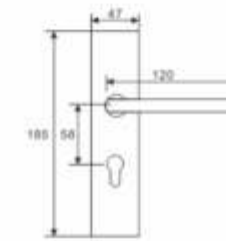

**5881-592 SN •**



**5881-592 BL •**

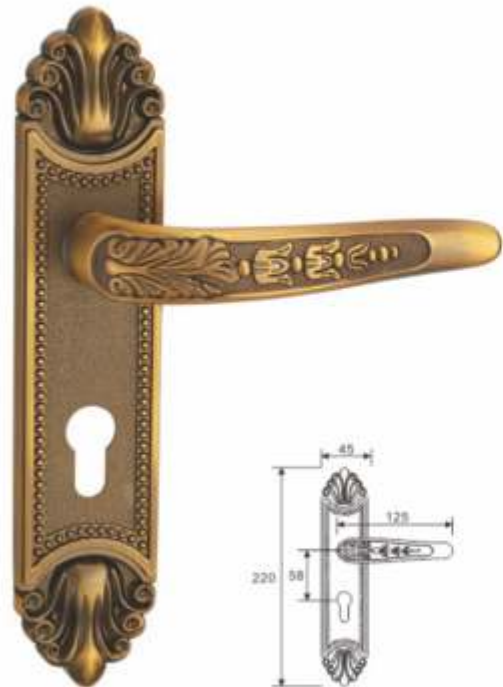

**5841-521 COF •**

- ④ 表面处理: 黄古铜  
Finish: COF
- ④ 材质: 锌合金  
Material: Zinc Alloy
- ④ 适用门厚: 38-50mm  
Door Thickness: 38-50mm
- ④ 适配锁体: 5845  
Lock body: 5845
- ④ 适用标准: QB/T2474-2000 GB21556-2008  
Applicable Standard: QB/T2474-2000 GB21556-2008

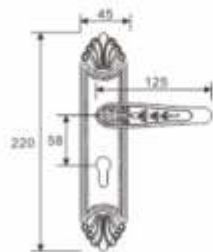

**5841-521 DAB •**



**5881-704 BL •**

- ④ 表面处理: 亚黑  
Finish: BL
- ④ 材质: 锌合金  
Material: Zinc Alloy
- ④ 适用门厚: 38-50mm  
Door Thickness: 38-50mm
- ④ 适配锁体: 5845  
Lock body: 5845
- ④ 适用标准: QB/T2474-2000 GB21556-2008  
Applicable Standard: QB/T2474-2000 GB21556-2008

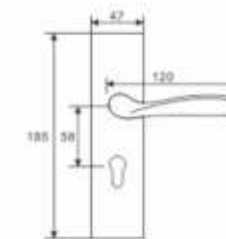

**5881-704 SN •**

### 58125-704 PVD •

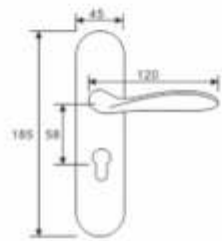
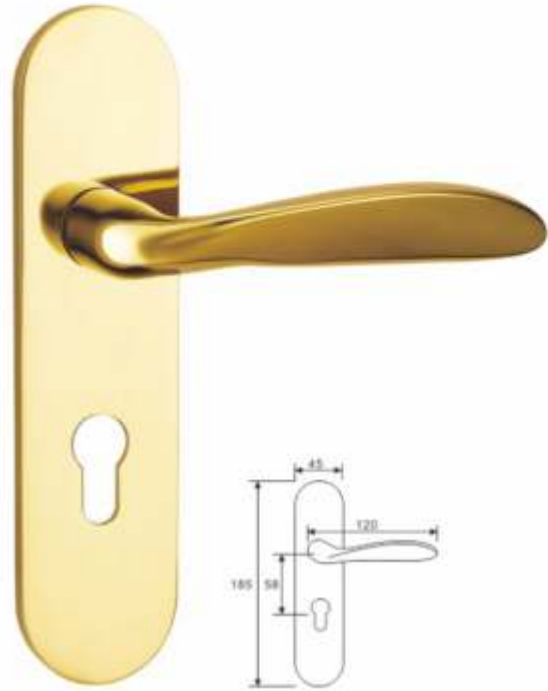

- ④ 表面处理: 镀金  
Finish: PVD
- ④ 材质: 锌合金  
Material: Zinc Alloy
- ④ 适用门厚: 38-50mm  
Door Thickness: 38-50mm
- ④ 适配锁体: 5845  
Lock body: 5845
- ④ 适用标准: QB/T2474-2000 GB21556-2008  
Applicable Standard: QB/T2474-2000 GB21556-2008



58125-704 SN •

58125-704 CP •

### 58125-584 PVD •

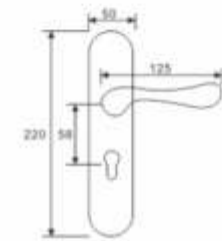
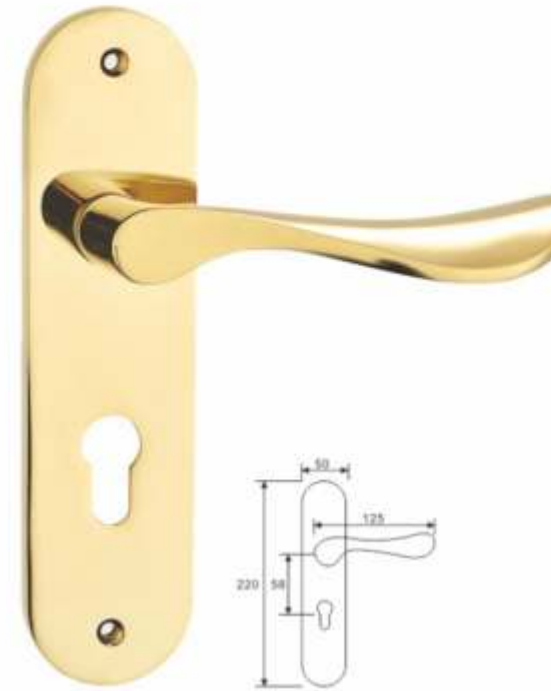

- ④ 表面处理: 镀金  
Finish: PVD
- ④ 材质: 锌合金  
Material: Zinc Alloy
- ④ 适用门厚: 38-50mm  
Door Thickness: 38-50mm
- ④ 适配锁体: 5845  
Lock body: 5845
- ④ 适用标准: QB/T2474-2000 GB21556-2008  
Applicable Standard: QB/T2474-2000 GB21556-2008



58125-584 BL •

58125-584 SN •

### 58150-704 DAB •

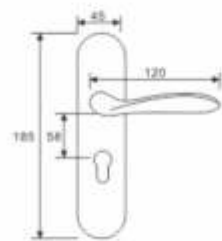
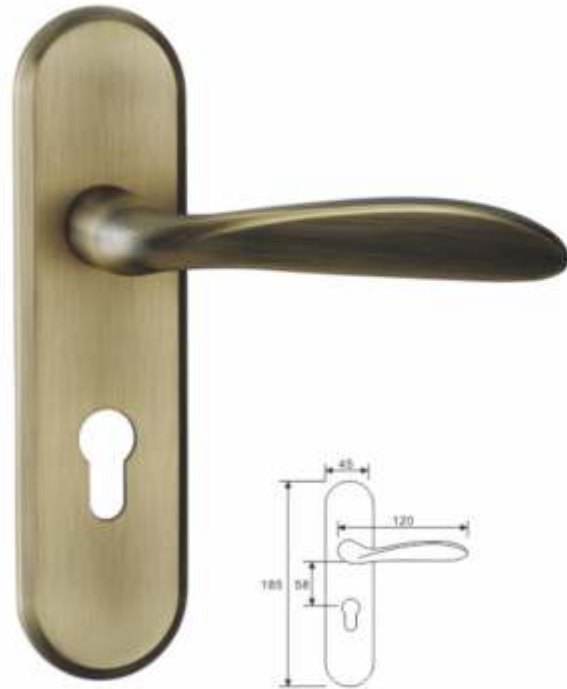

- ④ 表面处理: 青古铜  
Finish: DAB
- ④ 材质: 锌合金  
Material: Zinc Alloy
- ④ 适用门厚: 38-50mm  
Door Thickness: 38-50mm
- ④ 适配锁体: 5845  
Lock body: 5845
- ④ 适用标准: QB/T2474-2000 GB21556-2008  
Applicable Standard: QB/T2474-2000 GB21556-2008



58150-704 BL •

58150-704 SN •

### 5893-584 SN/CP •

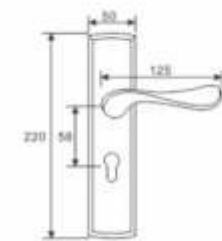

- ④ 表面处理: 镀镍/镀铬  
Finish: SN/CP
- ④ 材质: 锌合金  
Material: Zinc Alloy
- ④ 适用门厚: 38-50mm  
Door Thickness: 38-50mm
- ④ 适配锁体: 5845  
Lock body: 5845
- ④ 适用标准: QB/T2474-2000 GB21556-2008  
Applicable Standard: QB/T2474-2000 GB21556-2008



5893-584 BN/GP •

### 58127-706 ORB •

- ④ 表面处理: 黑红古铜  
Finish: ORB
- ④ 材质: 锌合金  
Material: Zinc Alloy
- ④ 适用门厚: 38-50mm  
Door Thickness: 38-50mm
- ④ 适配锁体: 5845  
Lock body: 5845
- ④ 适用标准: QB/T2474-2000 GB21556-2008  
Applicable Standard: QB/T2474-2000 GB21556-2008



58127-706 COF •

### 58126-705 HAB •

- ④ 表面处理: 雪花青古  
Finish: HAB
- ④ 材质: 锌合金  
Material: Zinc Alloy
- ④ 适用门厚: 38-50mm  
Door Thickness: 38-50mm
- ④ 适配锁体: 5845  
Lock body: 5845
- ④ 适用标准: QB/T2474-2000 GB21556-2008  
Applicable Standard: QB/T2474-2000 GB21556-2008

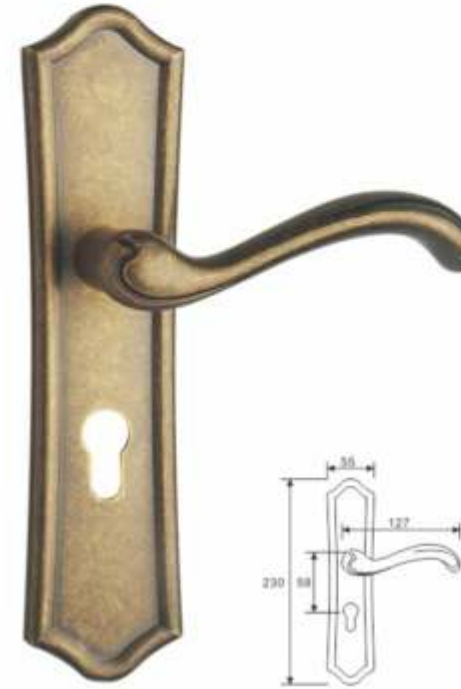

58126-705 HAC •



58126-705 DAB •

### 58128-707 ORB •

- ④ 表面处理: 黑红古铜  
Finish: ORB
- ④ 材质: 锌合金  
Material: Zinc Alloy
- ④ 适用门厚: 38-50mm  
Door Thickness: 38-50mm
- ④ 适配锁体: 5845  
Lock body: 5845
- ④ 适用标准: QB/T2474-2000 GB21556-2008  
Applicable Standard: QB/T2474-2000 GB21556-2008

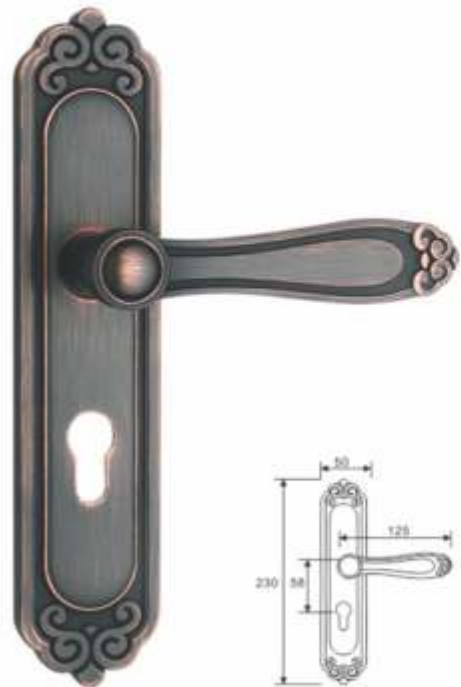

58128-707 COF •

### 58129-708 ORB •

- ④ 表面处理: 黑红古铜  
Finish: ORB
- ④ 材质: 锌合金  
Material: Zinc Alloy
- ④ 适用门厚: 38-50mm  
Door Thickness: 38-50mm
- ④ 适配锁体: 5845  
Lock body: 5845
- ④ 适用标准: QB/T2474-2000 GB21556-2008  
Applicable Standard: QB/T2474-2000 GB21556-2008

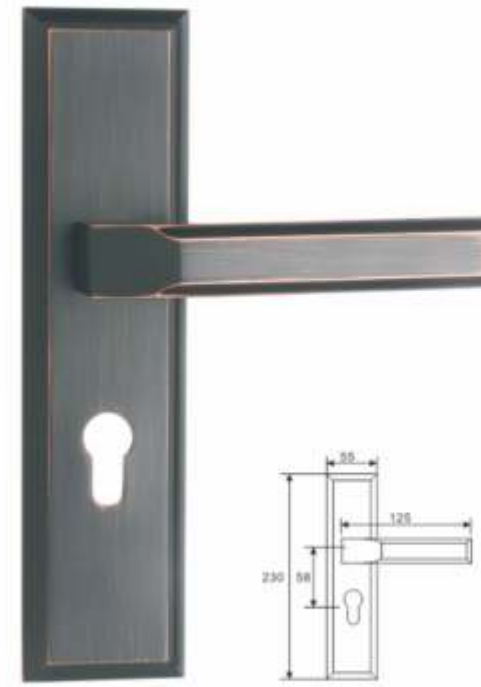

58129-708 SN •



58129-708 DAB •

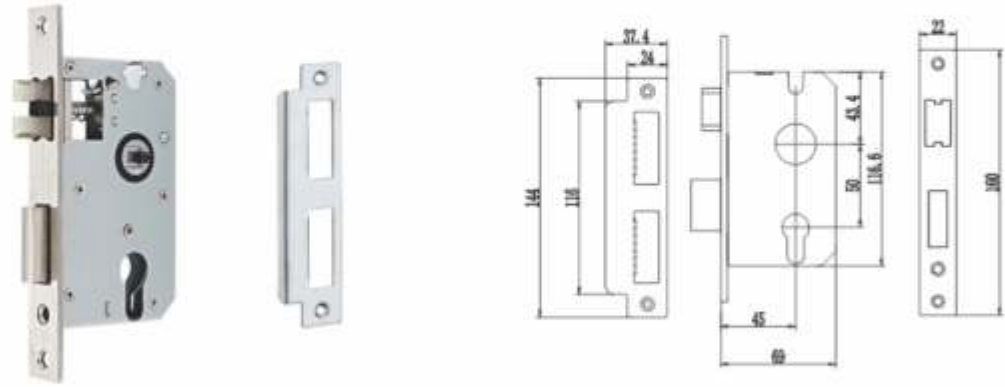

5002H-45 防插消音锁体



小70系列锁芯

**安装说明 Installation Instruction**

1. 安装锁体，预紧锁体螺钉
  2. 装面板，把手，并预紧螺钉，调整位置，使把手动作正常
  3. 安装锁芯，并预紧锁芯螺钉，转动钥匙和钥匙，确定转动无阻碍后，紧固锁芯螺钉
  4. 安装扣板，并预紧螺钉，调整位置，达到上锁，开锁自如，调整到最佳状态后，紧固所有螺钉，完成安装。
1. install the lock body and pre-tighten the screws
  2. install the escutcheons and handles, and then pre-tighten the screws; adjust the position to enable the handles move smoothly.
  3. insert the cylinder, pre-tighten the screws, turning the key and knob, ensure them move smoothly and then tighten the screws
  4. install the plastic striking plate, and then pre-tighten the screws; adjust the position to enable lock and unlock smoothly, adjust to the best working condition, and then tighten all screws

- 表面处理:** 不锈钢拉丝、钛金拉丝、镀拉丝、青古铜、红古铜  
Finish: SS/SPVD/SN/AB/AC
- 主要材质:** 不锈钢、铜、铁、锌  
Material: Stainless steel/Brass/iron
- 类型 Features:**  
插芯锁体 Mortise Lock
- 技术参数 Technical Data:**
1. 拨轮方芯 Lever follower: 8.2x8.2mm
  2. 中心距 Center Length(A): 50mm
  3. 门边距 Edge Distance: 45mm
- 配置附件 Accessories:**
1. 自攻螺丝 Screws
  2. 扣板 Striking Plate
  3. 塑料扣盒 Plastic Strike Box

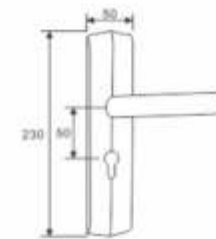
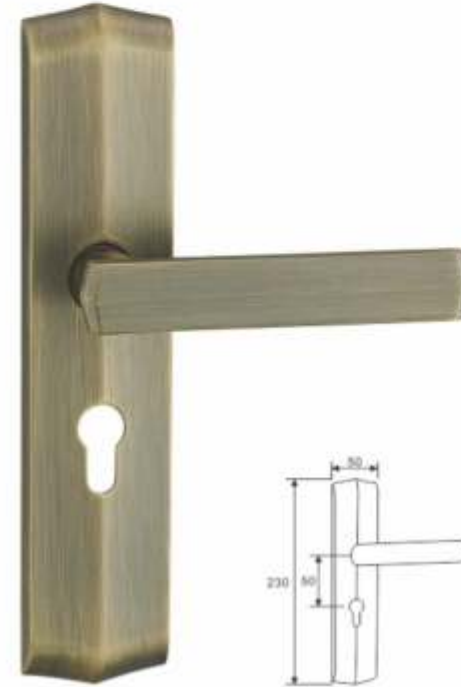

**5036-337 DAB**

- 表面处理: 青古铜  
Finish: DAB
- 材质: 锌合金  
Material: Zinc Alloy
- 适用门厚: 38-50mm  
Door Thickness: 38-50mm
- 适配锁体: 5045  
Lock body: 5045
- 适用标准: QB/T2474-2000 GB21556-2008  
Applicable Standard: QB/T2474-2000 GB21556-2008



5036-337 GPC

5036-337 COF

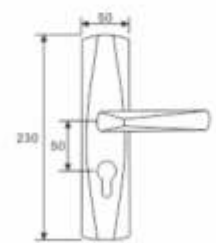
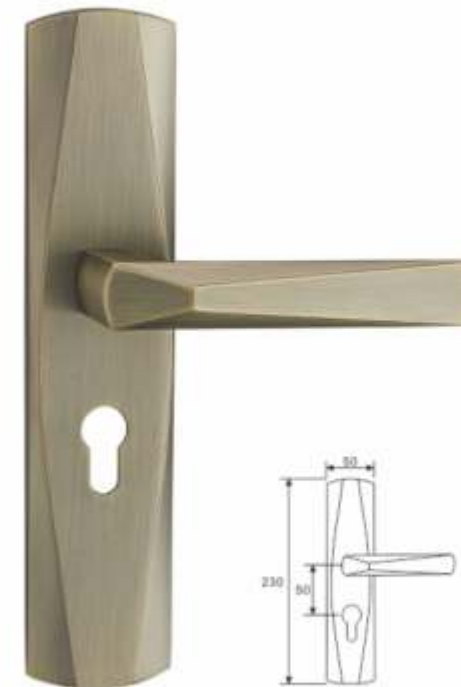

**5037-338 DAB**

- 表面处理: 青古铜  
Finish: DAB
- 材质: 锌合金  
Material: Zinc Alloy
- 适用门厚: 38-50mm  
Door Thickness: 38-50mm
- 适配锁体: 5045  
Lock body: 5045
- 适用标准: QB/T2474-2000 GB21556-2008  
Applicable Standard: QB/T2474-2000 GB21556-2008



5037-338 GPC

5037-338 COF

### 5038-339 COF •



- ④ 表面处理: 黄古铜  
Finish: COF
- ⑤ 材质: 锌合金  
Material: Zinc Alloy
- ⑥ 适用门厚: 38-50mm  
Door Thickness: 38-50mm
- ⑦ 适配锁体: 5045  
Lock body: 5045
- ⑧ 适用标准: QB/T2474-2000 GB21556-2008  
Applicable Standard: QB/T2474-2000 GB21556-2008

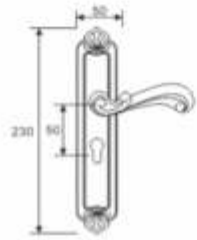

5038-339 GPC •



5038-339 BN/GP •

### 5020-321 BN/GP •

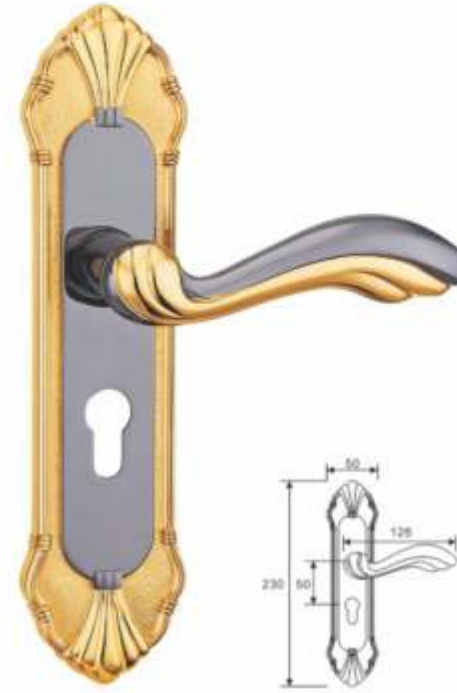

- ④ 表面处理: 钛黑金  
Finish: BN/GP
- ⑤ 材质: 锌合金  
Material: Zinc Alloy
- ⑥ 适用门厚: 38-50mm  
Door Thickness: 38-50mm
- ⑦ 适配锁体: 5045  
Lock body: 5045
- ⑧ 适用标准: QB/T2474-2000 GB21556-2008  
Applicable Standard: QB/T2474-2000 GB21556-2008

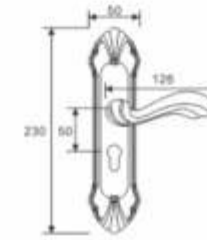

5020-321 DAB •



5020-321 COF •

### 5039-340 COF •



- ④ 表面处理: 黄古铜  
Finish: COF
- ⑤ 材质: 锌合金  
Material: Zinc Alloy
- ⑥ 适用门厚: 38-50mm  
Door Thickness: 38-50mm
- ⑦ 适配锁体: 5045  
Lock body: 5045
- ⑧ 适用标准: QB/T2474-2000 GB21556-2008  
Applicable Standard: QB/T2474-2000 GB21556-2008

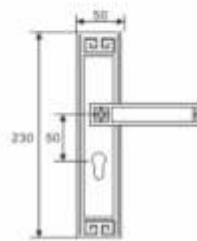

5039-340 DAB •



5039-340 ORC •

### 5040-341 COF •

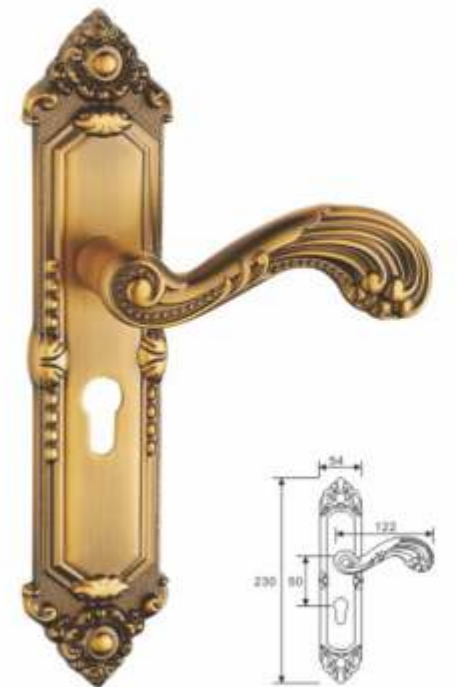

- ④ 表面处理: 黄古铜  
Finish: COF
- ⑤ 材质: 锌合金  
Material: Zinc Alloy
- ⑥ 适用门厚: 38-50mm  
Door Thickness: 38-50mm
- ⑦ 适配锁体: 5045  
Lock body: 5045
- ⑧ 适用标准: QB/T2474-2000 GB21556-2008  
Applicable Standard: QB/T2474-2000 GB21556-2008

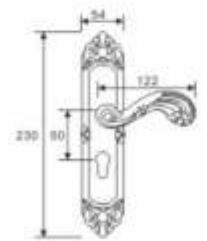

5040-341 GPC •



5040-341 DAB •



单舌锁芯

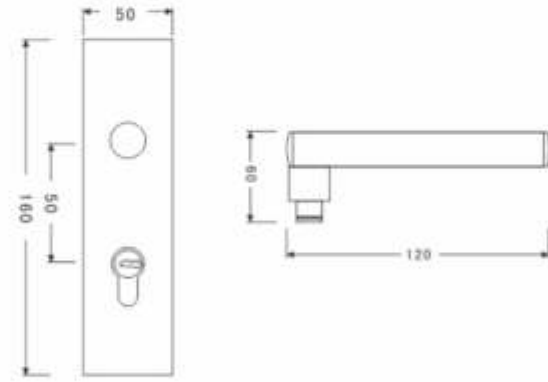

CXA5881-592 SN

- ② 表面处理: 镍拉丝  
Finish: SN
- ③ 材质: 锌合金  
Material: Zinc Alloy
- ④ 选配锁体: 单舌锁体  
Lock body: Single tongue lock body



CXA5881-704 SN

- ② 表面处理: 镍拉丝  
Finish: SN
- ③ 材质: 锌合金  
Material: Zinc Alloy
- ④ 选配锁体: 单舌锁体  
Lock body: Single tongue lock body



单舌锁体

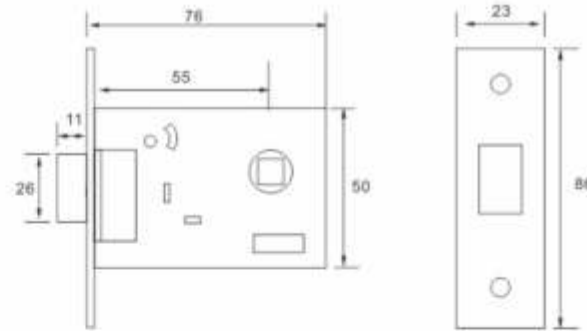

CXA58125-704 SN

- ② 表面处理: 镍拉丝  
Finish: SN
- ③ 材质: 锌合金  
Material: Zinc Alloy
- ④ 选配锁体: 单舌锁体  
Lock body: Single tongue lock body



CXA58149-584 SN

- ② 表面处理: 镍拉丝  
Finish: SN
- ③ 材质: 锌合金  
Material: Zinc Alloy
- ④ 选配锁体: 单舌锁体  
Lock body: Single tongue lock body

**安装说明 Installation Instruction**

1. 安装锁体, 预紧锁体螺钉
2. 装面板、把手, 并预紧螺钉, 再整位置, 使把手动作正常
3. 安装锁芯, 并预紧锁芯螺钉, 转动旋钮和钥匙, 确定转动无阻落后, 紧定锁芯螺钉
4. 安装扣板, 并预紧螺钉; 调整位置, 达到上锁, 开锁自如。调整到最佳状态后, 紧固所有螺钉, 完成安装。

1. install the lock body and pre-tighten the screws
2. install the escutcheons and handles, and then pre-tighten the screws; adjust the position to enable the handles move smoothly.
3. insert the cylinder, pre-tighten the screws turning the key and knob, ensure them move smoothly and then tighten the screws
4. install the plastic striking plate, and then pre-tighten the screws; adjust the position to enable lock and unlock smoothly; adjust to the best working condition, and then tighten all screws

表面处理: 不锈钢拉丝, 镀金拉丝, 镍拉丝, 青古铜, 红古铜  
Finish: SS/SPVD/SN/AB/AC

主要材质: 不锈钢, 铜, 铁, 锌  
Material: Stainless steel/Brass/iron

**类型 Features:**

插芯锁体 Mortise Lock

**技术参数 Technical Data:**

1. 扳轮方芯 Lever follower;
2. 中心距 Center Length(A):
3. 门边距 Edge Distance: 50mm

**配置附件 Accessories:**

1. 自攻螺丝 Screws
2. 扣板 Striking Plate
3. 塑料扣盒 Plastic Strike Box

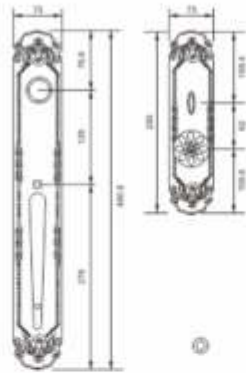

**DL9403-A002 DAB**

- ① 表面处理: 青古铜  
Finish: DAB
- ② 材质: 锌合金  
Material: Zinc Alloy
- ③ 选配锁体: 7094  
Install the door so from: 7094

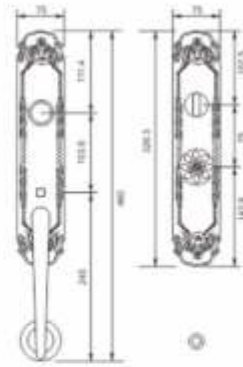

**DM7503-A001 DAB**

- ① 表面处理: 青古铜  
Finish: DAB
- ② 材质: 锌合金  
Material: Zinc Alloy
- ③ 选配锁体: 7560  
Install the door so from: 7560

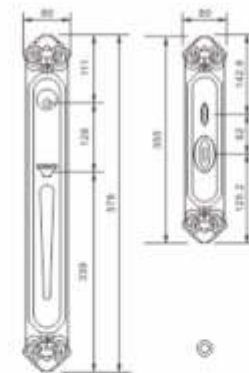

**DL9401-A001 ABB**

- ① 表面处理: 雪花古铜  
Finish: ABB
- ② 材质: 锌合金  
Material: Zinc Alloy
- ③ 选配锁体: 7094  
Install the door so from: 7094

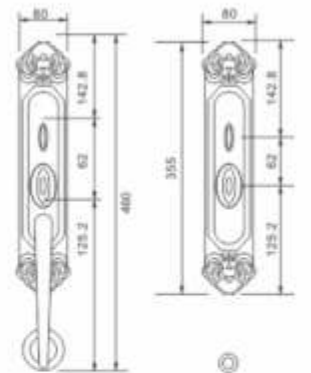

**DM7501-A001 COF**

- ① 表面处理: 黄古铜  
Finish: ACU
- ② 材质: 锌合金  
Material: Zinc Alloy
- ③ 选配锁体: 7560  
Install the door so from: 7094





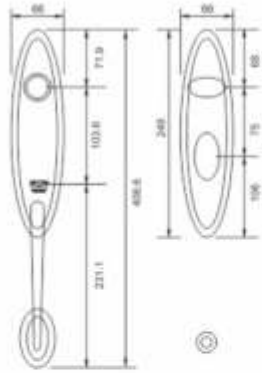

适配锁体: 7500-60

**DM7508-A002 SN/NP**

- ④ 表面处理: 镍拉丝/亮镍  
Finish: SN/NP
- ⑤ 材质: 锌合金  
Material: Zinc Alloy
- ⑥ 适配锁体: 7500  
Install the door so from: 7500

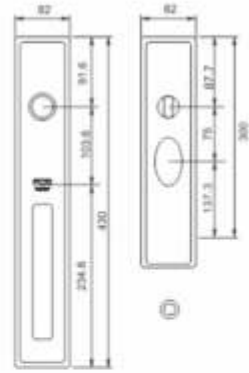

适配锁体: 7500-60

**DL7509-A002 SN/NP**

- ④ 表面处理: 镍拉丝/亮镍  
Finish: SN/NP
- ⑤ 材质: 锌合金  
Material: Zinc Alloy
- ⑥ 适配锁体: 7500  
Install the door so from: 7500

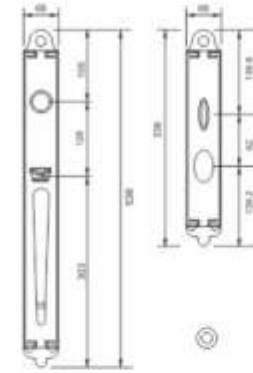

适配锁体: 7094

**DL9404-A002 PVD**

- ④ 表面处理: 镀金  
Finish: PVD
- ⑤ 材质: 锌合金  
Material: Zinc Alloy
- ⑥ 适配锁体: 7094  
Install the door so from: 7094

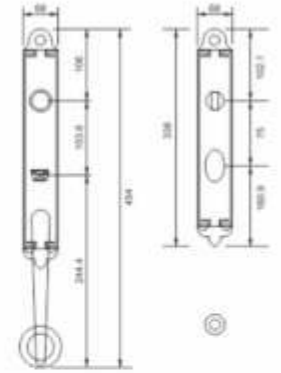

适配锁体: 7500-60

**DM7504-A002 PVD**

- ④ 表面处理: 镀金  
Finish: PVD
- ⑤ 材质: 锌合金  
Material: Zinc Alloy
- ⑥ 适配锁体: 7500  
Install the door so from: 7500

