

— **HANDLES COLLECTION** —

JINCHENG HARDWARE INDUSTRY CO.,LTD

Add: No. 191,Wudong Industrial Zone,
Lile Town, Jianghai Dist, Jiangmen,
Guangdong, China 529060.

Tel: +86-750-3166208

Fax: +86-750-3166206

E-mail: sales@jincheng-hw.cc

http: //www.jincheng-hw.com



Aluminium Serial



JIN
CHENG

Content

01 Aluminium Finish

02 Company Profile

03 Aluminum Gravity Casting Lever Handle Page 01-17

04 Other

Aluminium Turnkobs	Page 19
Aluminium Escutcheons	Page 19
Aluminium Back Plates	Page 20
Aluminium Signatures	Page 23
Aluminium Pull Handles	Page 24
Exterior & Interior Locksets	Page 25
Aluminium Door Stoppers	Page 26
Aluminium Hooks	Page 26

Aluminium Finish



E6EV1
(silber natur)



E6 C33
(mittelbronze)



E6 C32
(hellbronze)



E6 EV2
(neusilber)



E6 EV3
(gold)



E6 C34
(dunkelbronze)



E6 C31
(champagner)

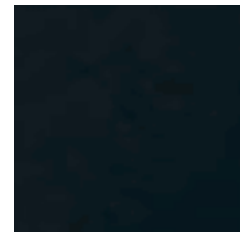

E6 C35
(schwarz)





About Us

JinCheng Hardware Industry Co.,Ltd is a manufacturer and supplier of architectural hardware to the construction industry, is located at Jiangmen city, Guangdong province in China Near HK and Macao. JinCheng products are both durable and versatile.

The JinCheng quality range of Architectural Hardware includes door hinges, Door Lever handles, pull handles, door stoppers, series of door-used hardware and small size metal components, etc.

Our focus on customers service, high quality and competitive price, which leading our goods are popular in America, Canada, Europe, Southeast. Asia, Middle-East and other countries abroad.

JinCheng's extensive range of Architectural Hardware products offers a well-priced package of functionality and style. Please feel free to contact JinCheng should you have any special requirements or if you would like one of our Architectural Consultants to call on you.

We look forward to helping you and thank you for your interest and support.

Also, we will be pleased to develop special OEM models for all customers. Please contact us now for more information.



Aluminum Gravity Casting Lever Handle



ALH001

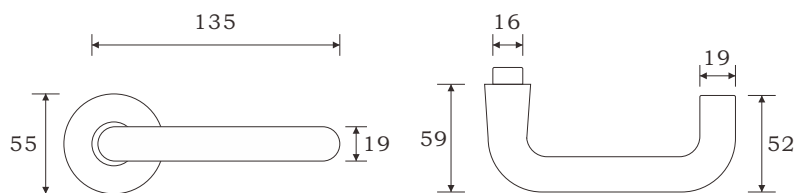

ALH002

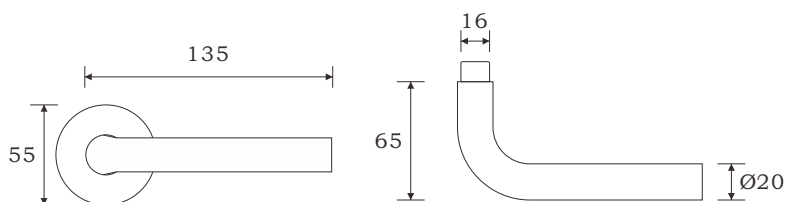

ALH003

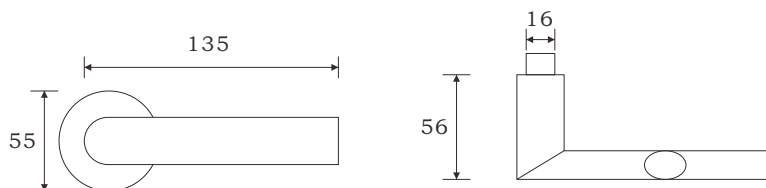

ALH004

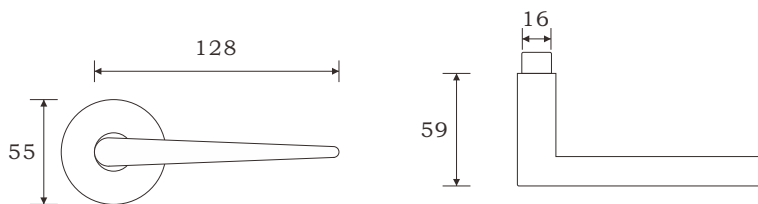

ALH005

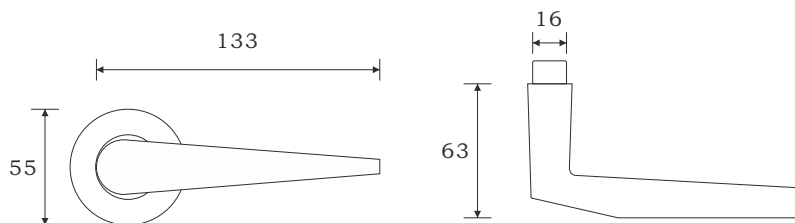

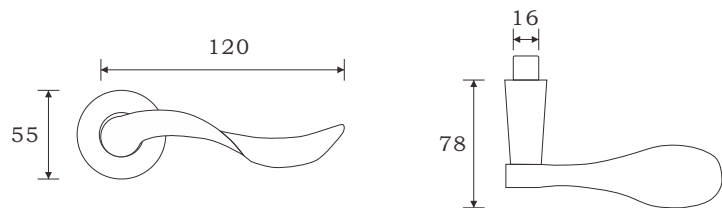
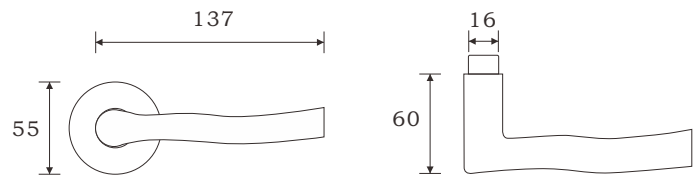
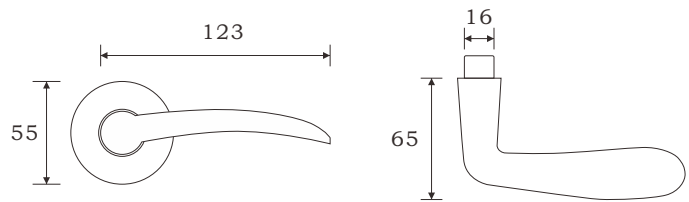
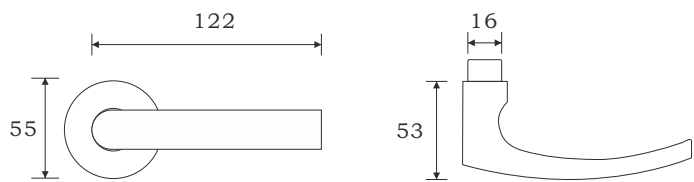
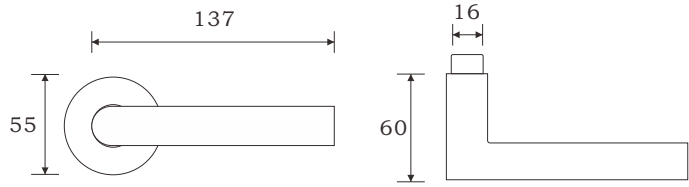



ALH014

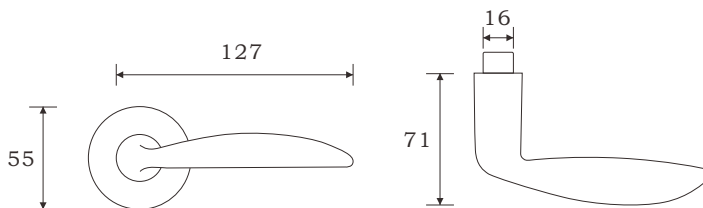

ALH015

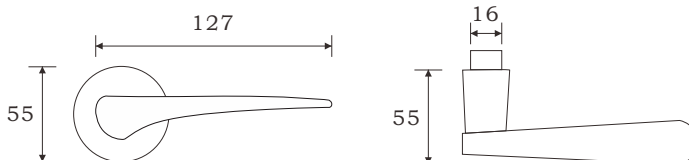

ALH016

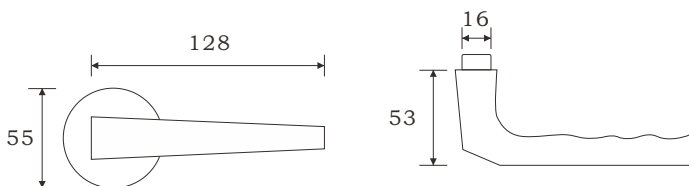

ALH017

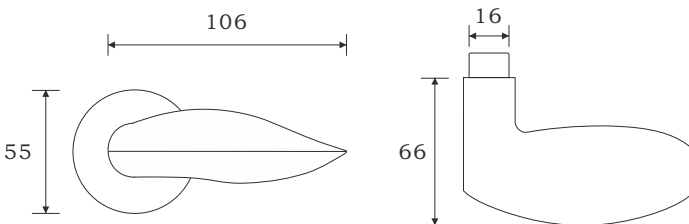

ALH018

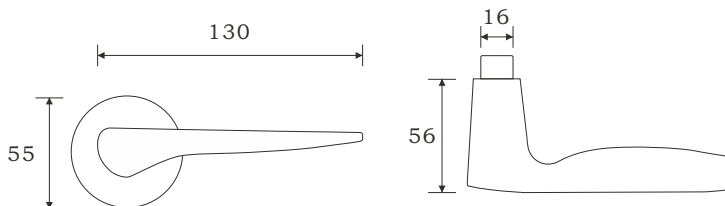



ALH019

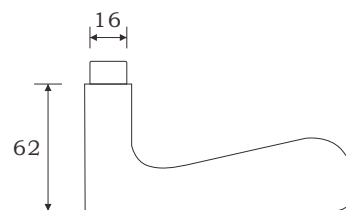
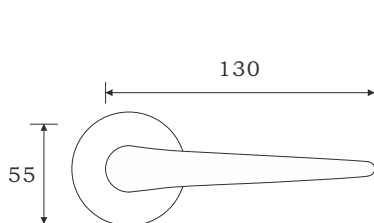

ALH020

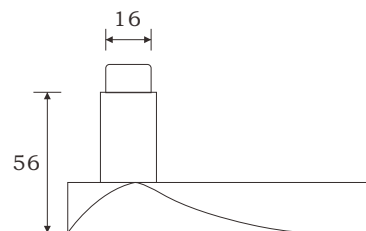
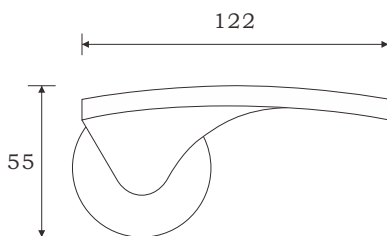

ALH021

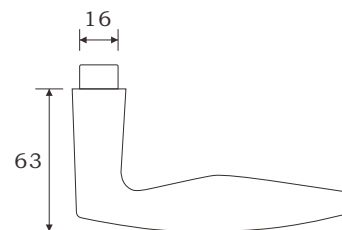
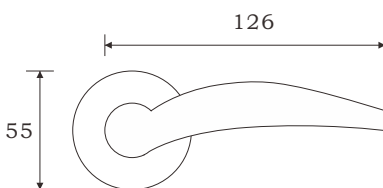

ALH022

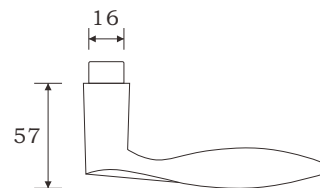
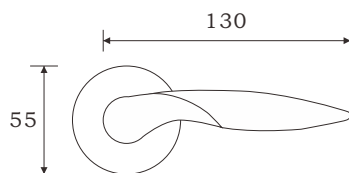

ALH023

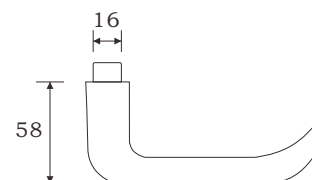
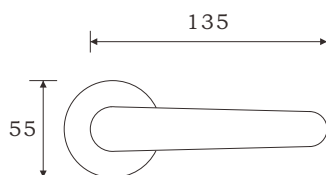

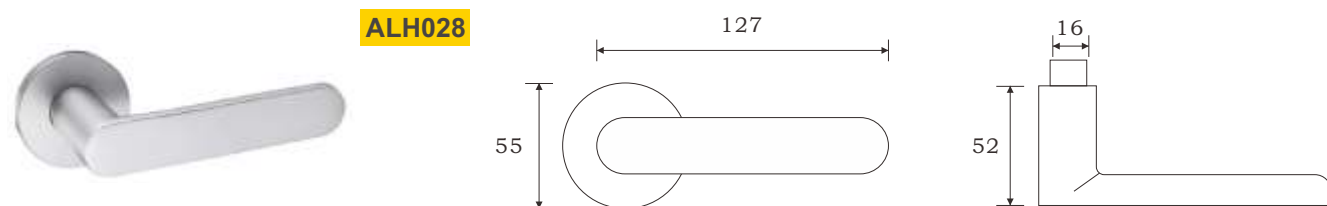
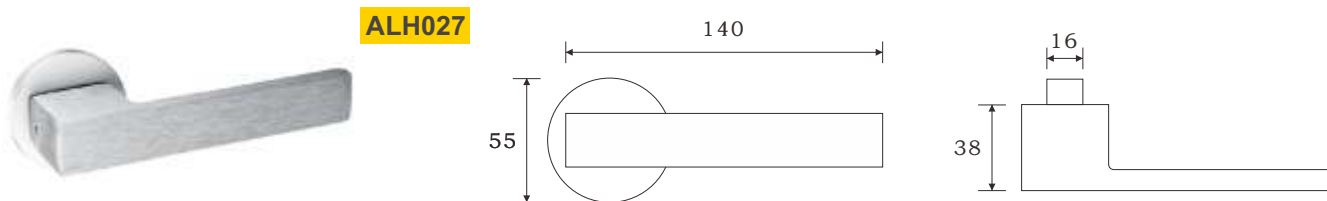
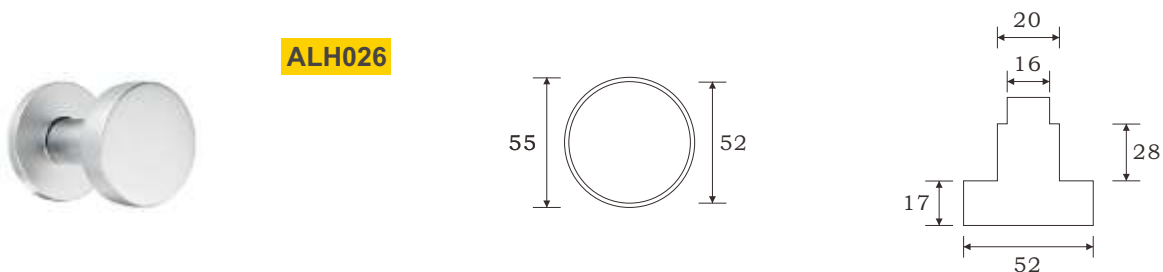
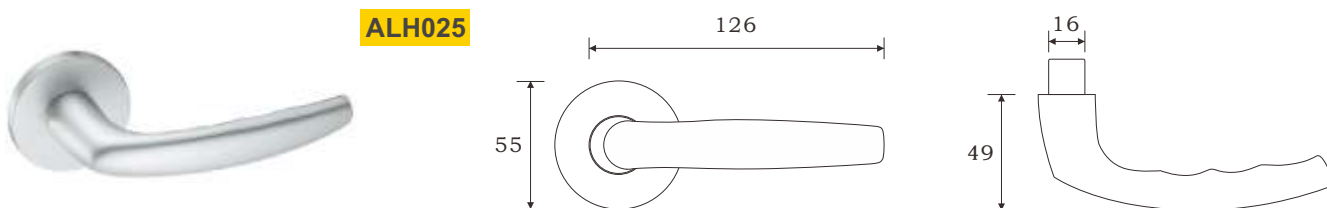
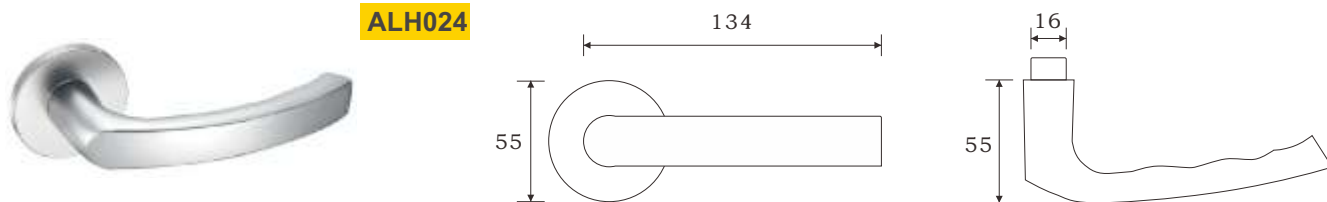

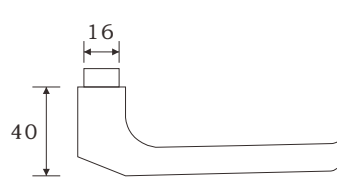
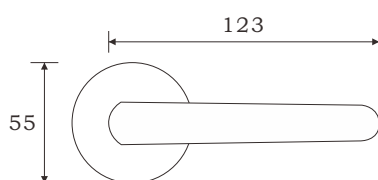
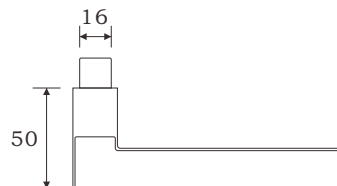
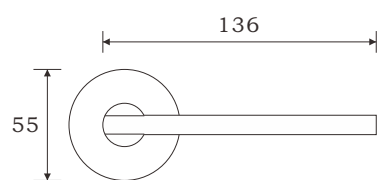
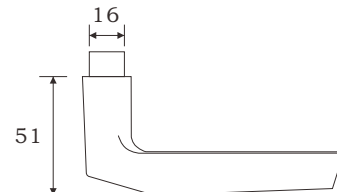
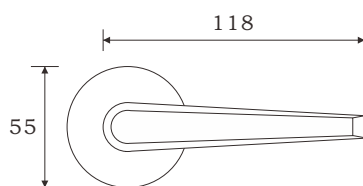
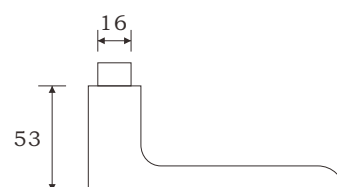
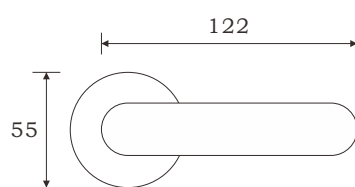
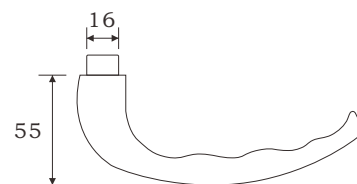
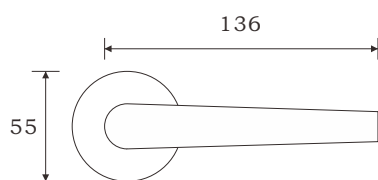



ALH037

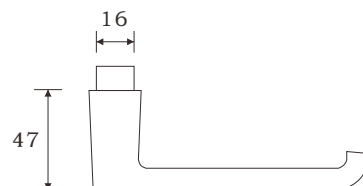
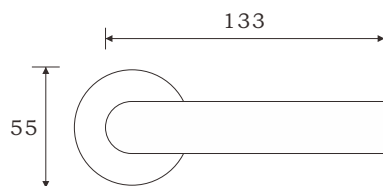

ALH038

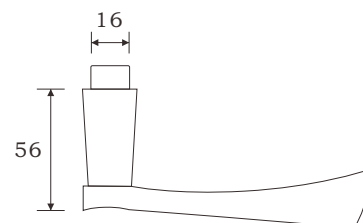
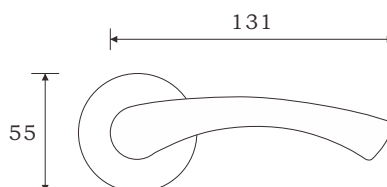

ALH039

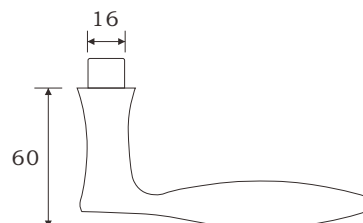
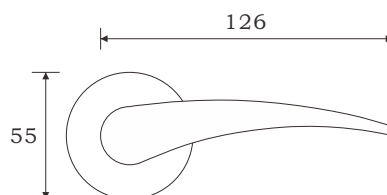

ALH040

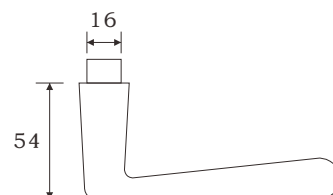
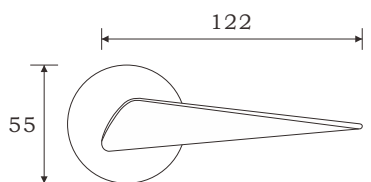

ALH041

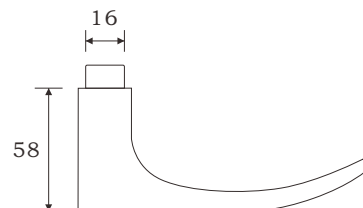
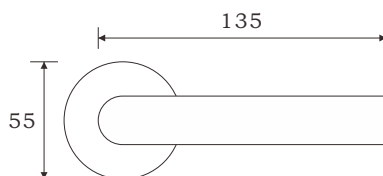

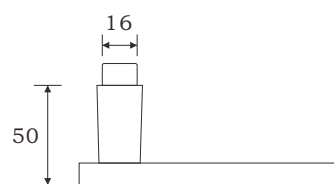
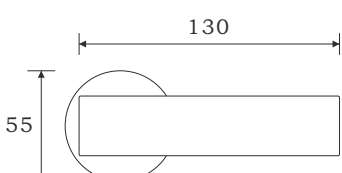
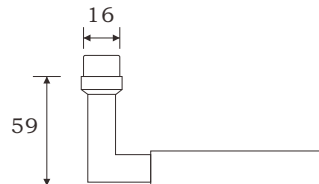
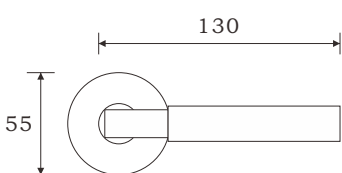
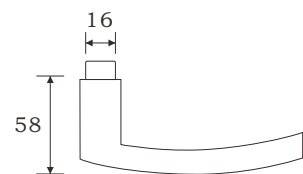
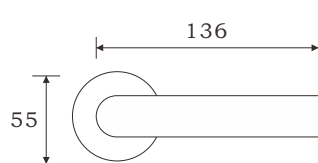
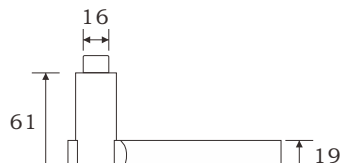
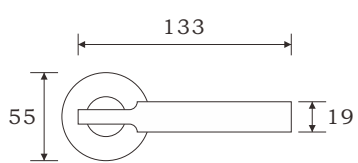
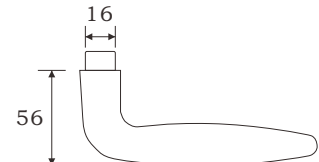
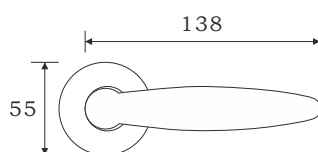

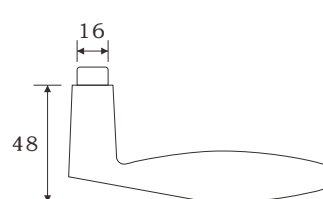
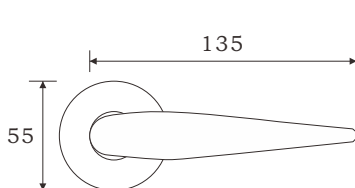
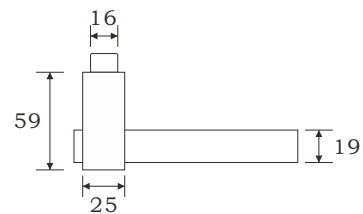
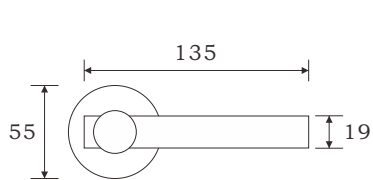
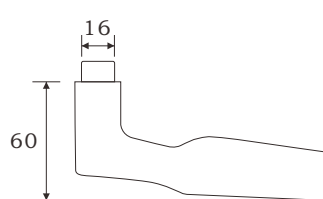
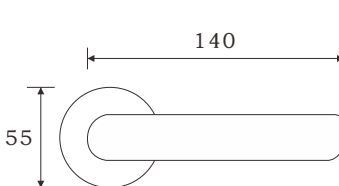
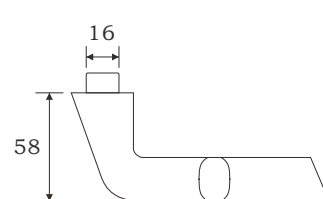
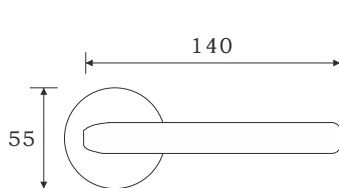
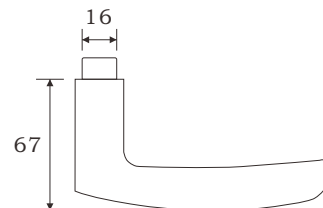
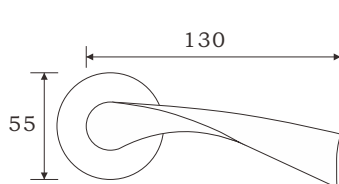

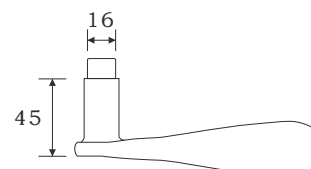
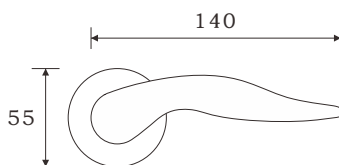
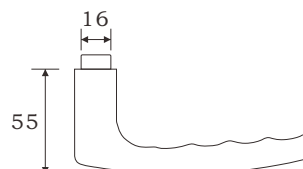
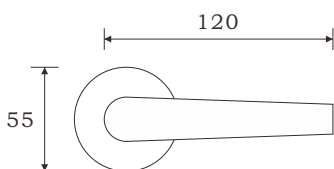
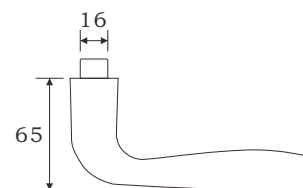
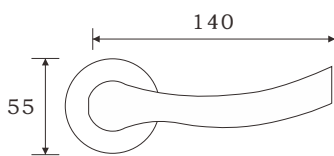
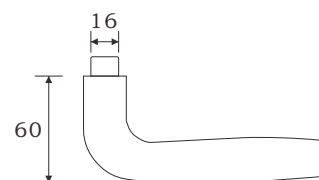
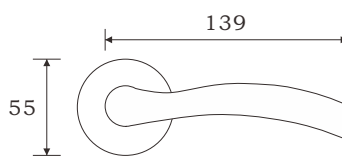
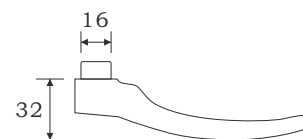
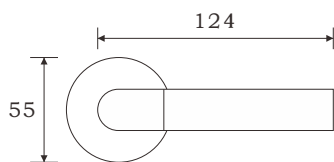

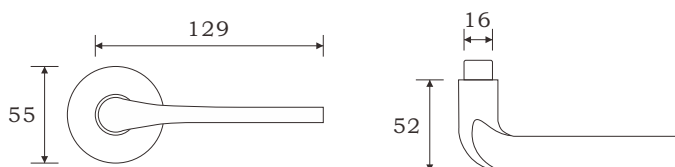
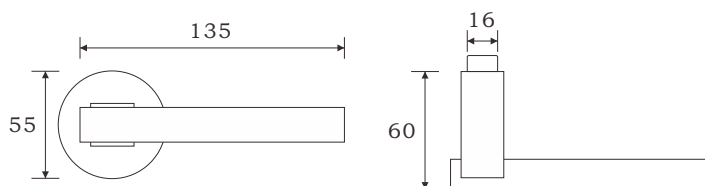
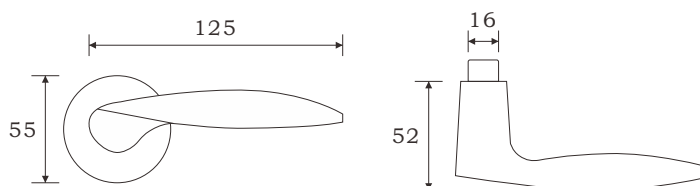
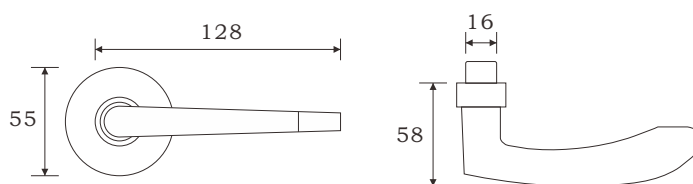
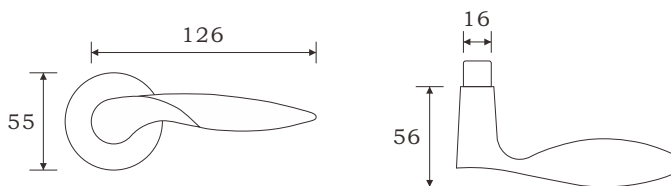

ALH071

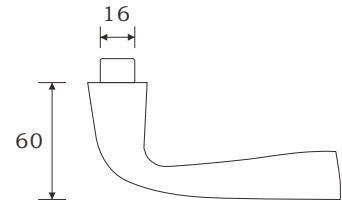
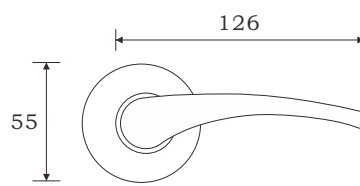

ALH072

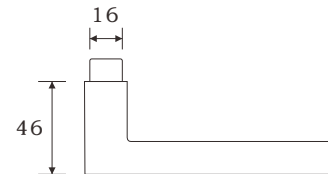
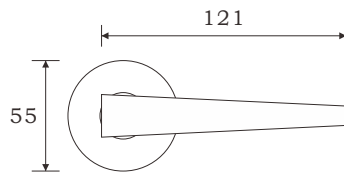

ALH073

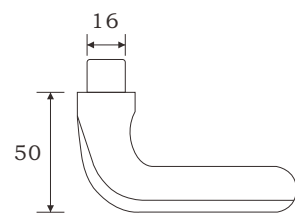
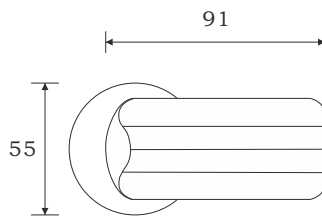

ALH074

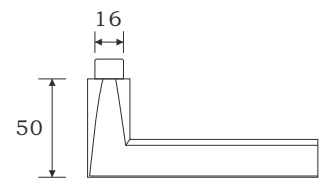
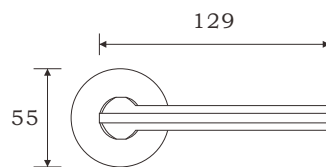

ALH075

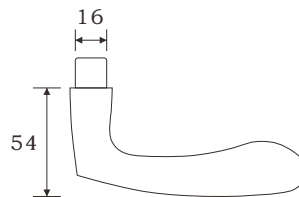
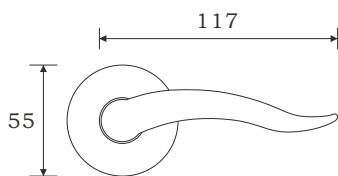

ALH076

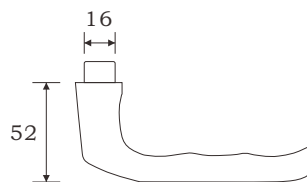
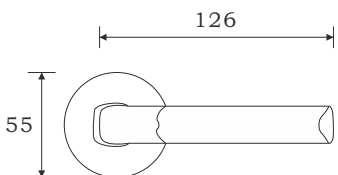

ALH080

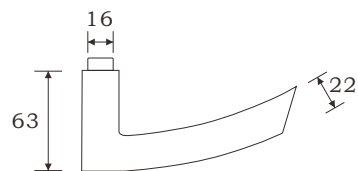
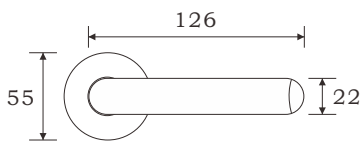

ALH081

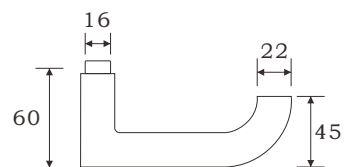
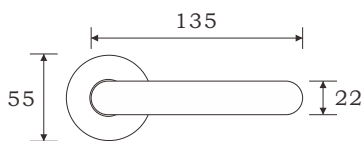

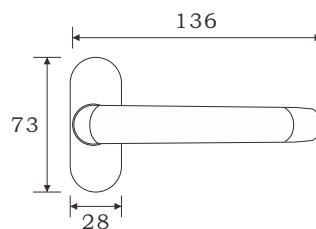
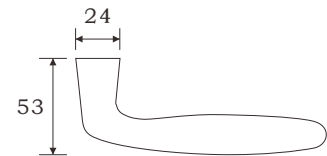
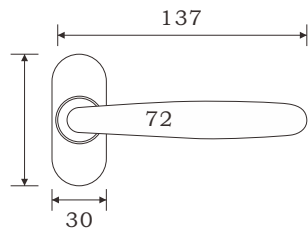
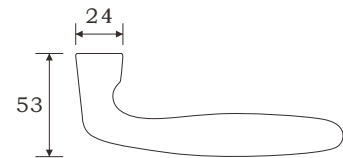
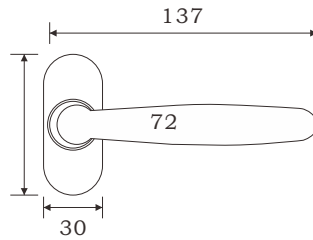
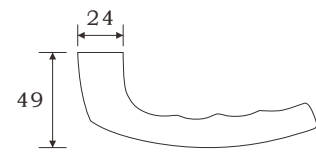
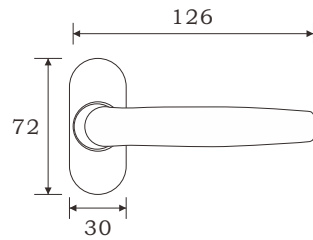
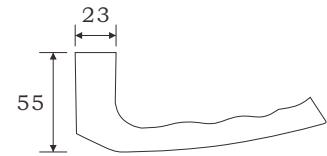
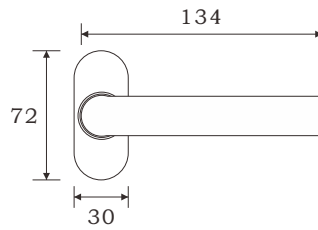

ALH004BLK

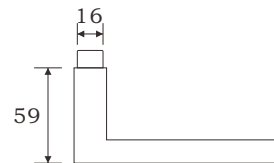
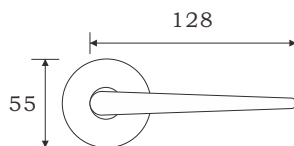

ALH011BLK

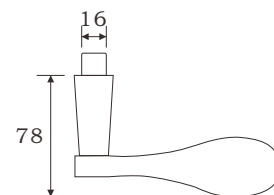
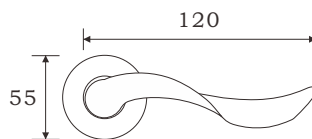

ALH017Rosegold

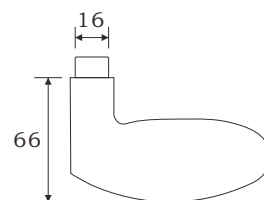
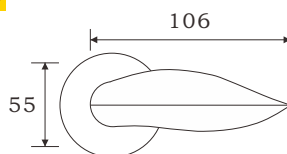

ALH030BLK

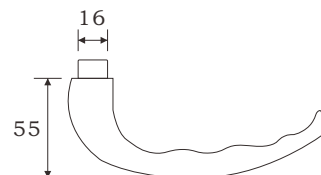
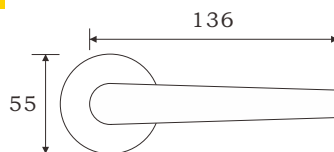

ALH030 F2

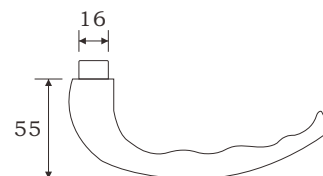
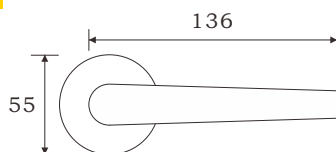

ALH033BLK

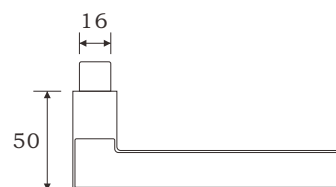
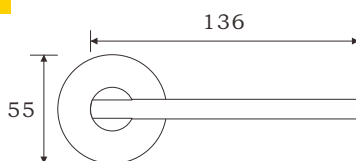

ALH038BLK

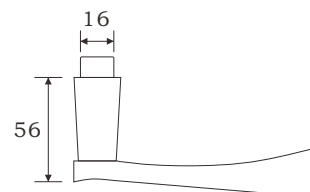
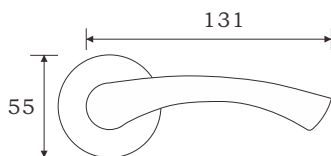

ALH071BLK

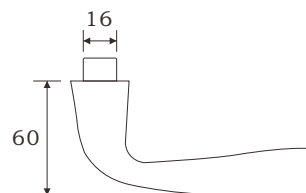
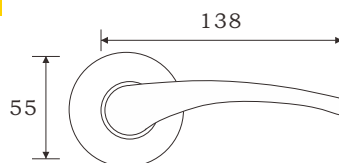

Others

■ Aluminum Turnknobs



W-024

Φ 52x8mm

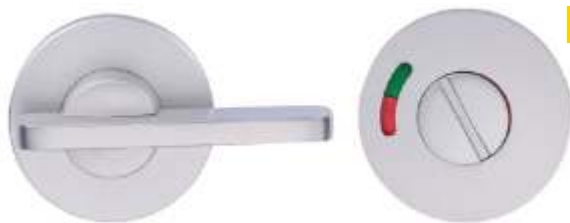

W-024

Φ 50x7mm



W-024

Φ 54x10mm

■ Aluminum Escutcheons



W-024

W-024

W-024

A	Φ 50x7mm
B	Φ 55x7mm



W-024

Φ 54x10mm

AP-01

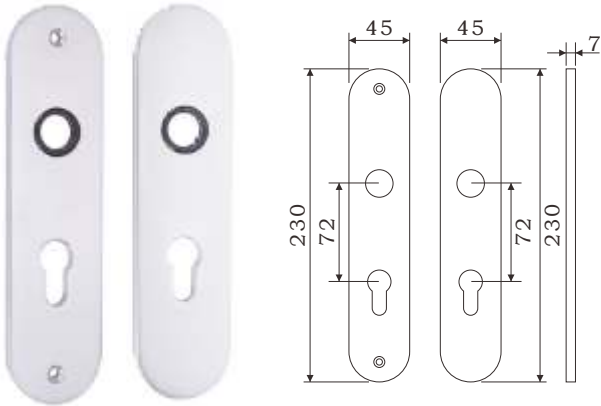

AP-02

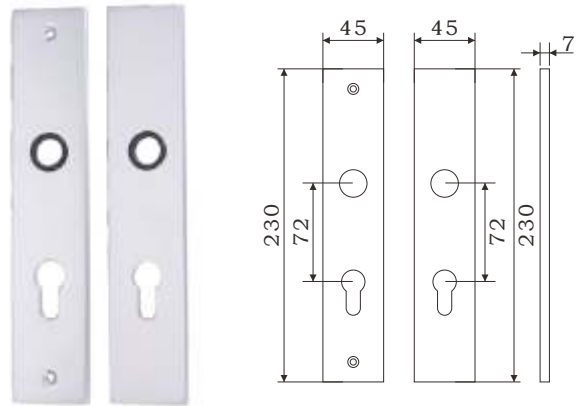

AP-03

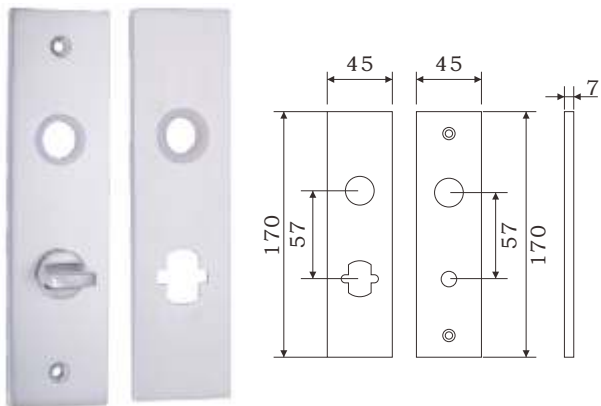

AP-04

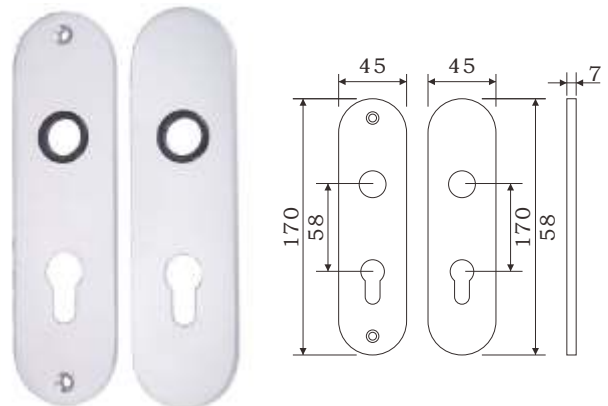

AP-05

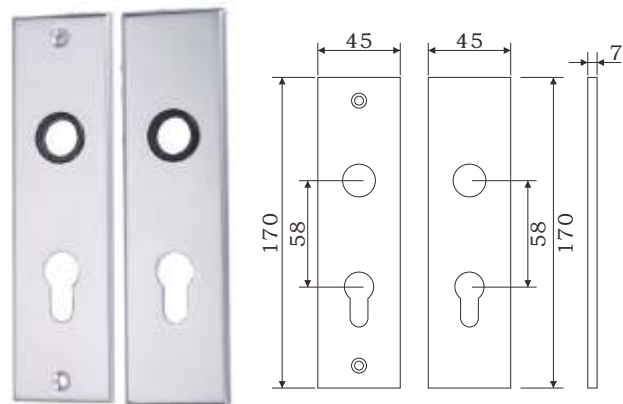

AP-06

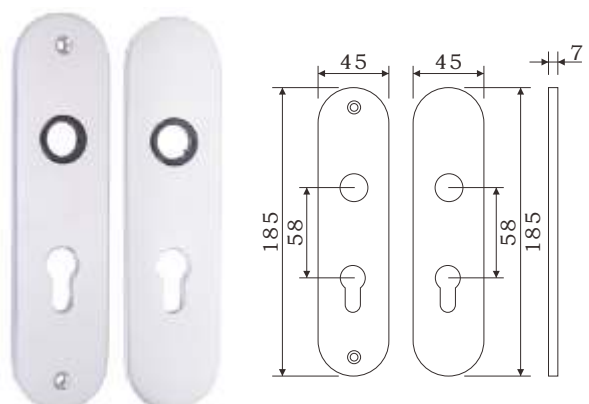

AP-07

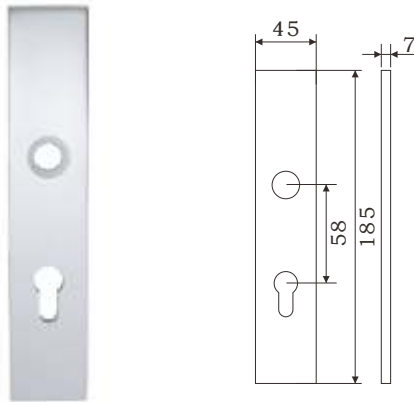

AP-08

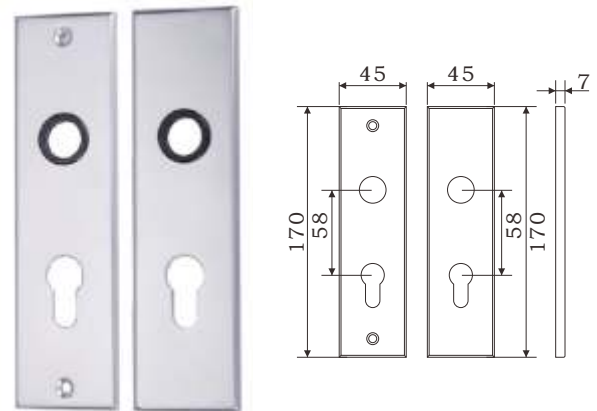

AP-09

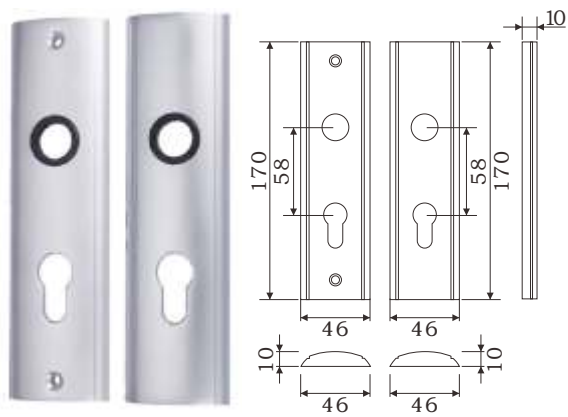

AP-10

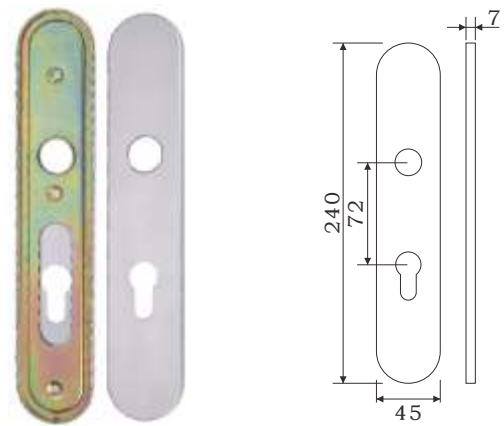

AP-11

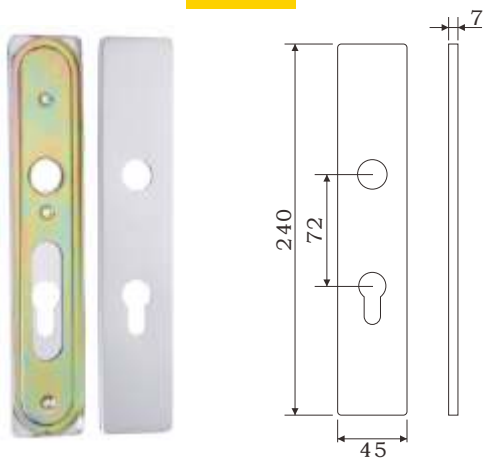

AP-12

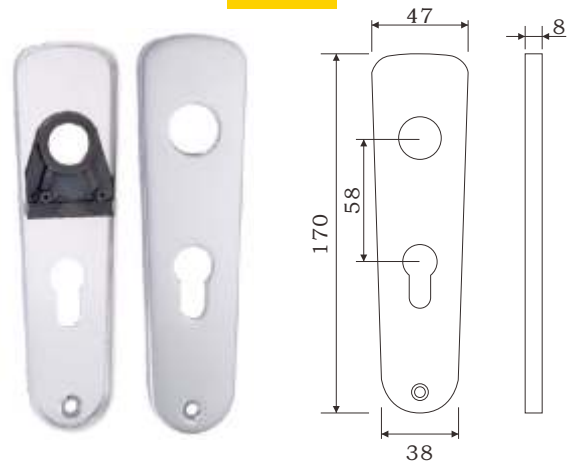

AP-13

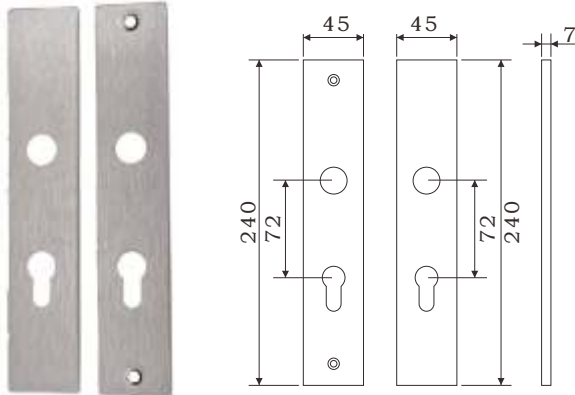

AP-14

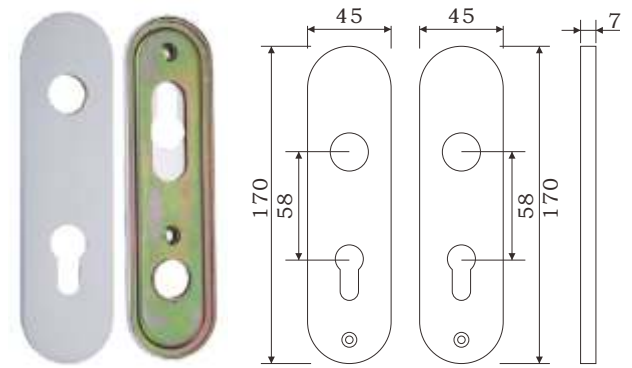

AP-15

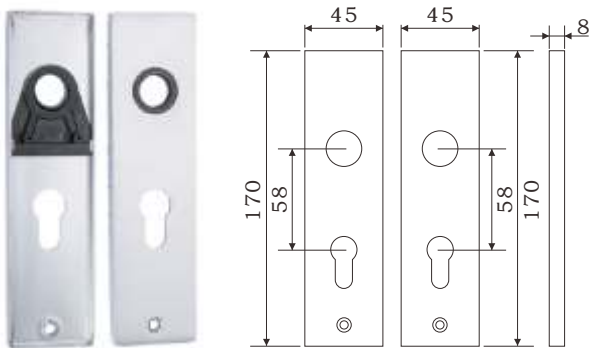

AP-16

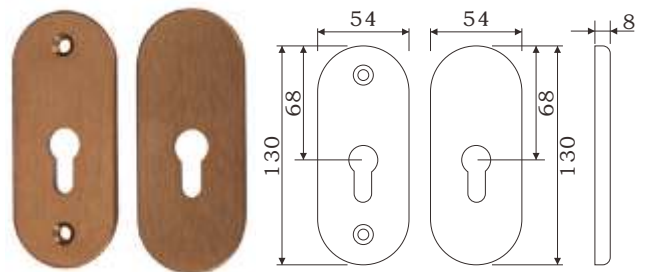

AP-17

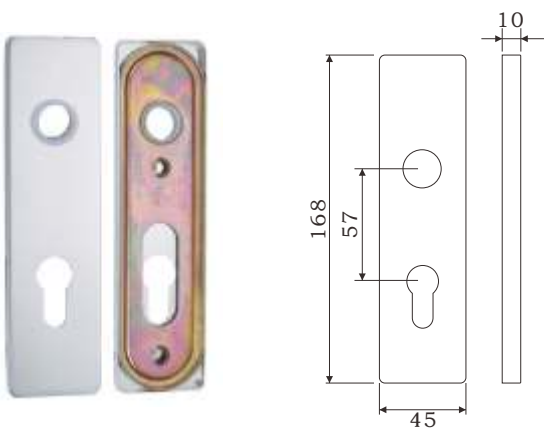

AP-18

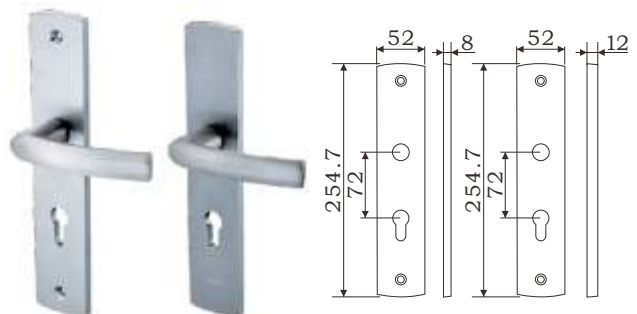

■ Aluminum Back Plates

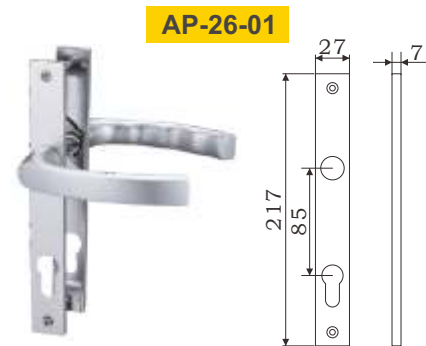
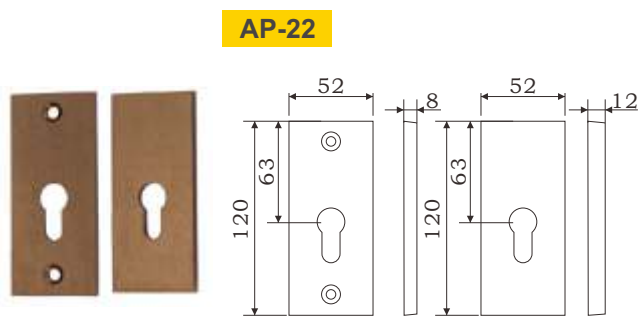
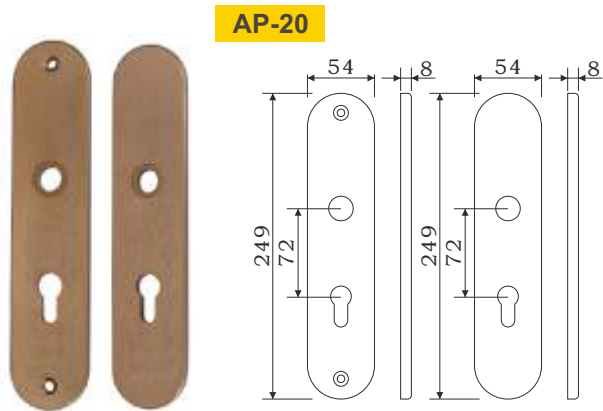

■ Aluminium Signatures



SN01

SN02

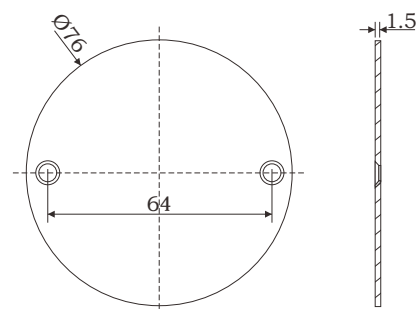

HTKLP1

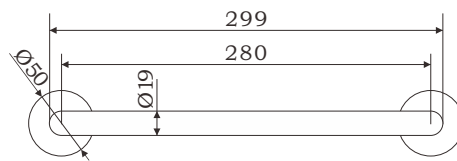

HTKLP2

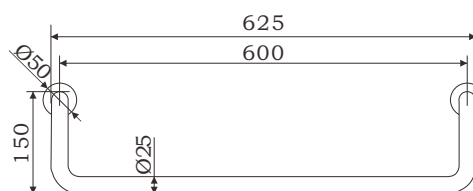

HTKLP3

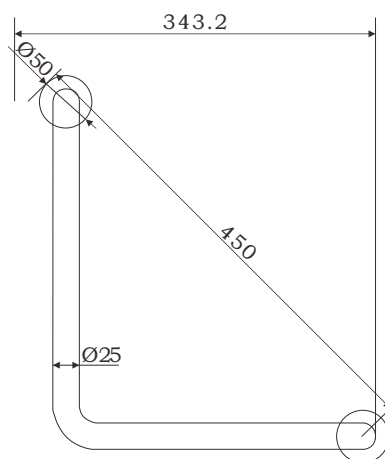

HTKLP4

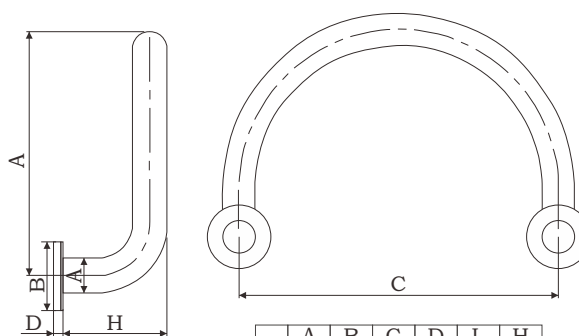

	A	B	C	D	L	H
1	Ø25	Ø50	250	6.5	175	75
2	Ø32	Ø50	350	6.5	239	95

■ Security Lockset



SL01

■ Exterior Lockset



SKN01

■ Interior Lockset



DL01

■ Aluminium Door Stoppers

ADS-01

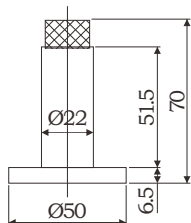

ADS-02

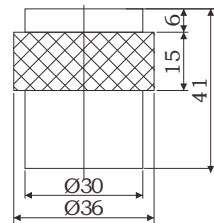

ADS-03

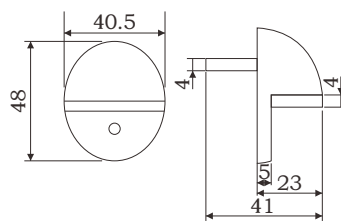

ADS-04

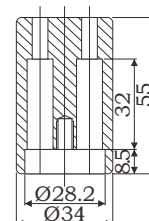

■ Aluminium Hooks

AHK-01

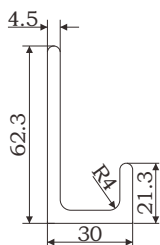

AHK-02

